

TABLE OF CONTENT

1 - FEATURES AND FUNCTIONS	4
2 - IMPORTANT WARNINGS	5
3 - PANEL DESCRIPTION	6
Front Panel	6
Rear Panel	7
4 - HARDWARE INSTALLATION ... part I	
Cables Connection	9
OLED Screen Description	10
Clipping	13
5 - HARDWARE INSTALLATION ... part II	
Microphones Setup	13
6 - micro KEYER III SOFTWARE INSTALLATION	16
Understanding USB Audio in the micro KEYER III	16
7 - macOS INSTALLATION	17
macOS USB Audio Setup	17
8 - Linux INSTALLATION	18
Linux USB Audio Setup	19
9 - Windows INSTALLATION	20
Windows USB Audio Setup	21
10 - Configuring microHAM USB Device Router	24
micro KEYER III Status	24
Troubleshooting:	24
11 - microHAM USB DEVICE ROUTER	25
VIRTUAL SERIAL PORTS	25
12 - DEVICE CONFIGURATION TABS	26
PORTS TAB	27
CAT Port	28
SDR Tracking	30
2nd CAT Port	31
FSK & 2nd FSK Ports	32
CW Port	34
PTT & 2nd PTT Ports	34
Foot Switch	34
WinKey Port	35
Auxiliary Port	36
Control Port	36
AUDIO SWITCHING TAB	37
Microphone Selection	39
Transmit Monitor	39
HARDWARE INSTALLATION ... part III	
Computer Audio Levels Setup	40
PTT TAB	41
Footswitch Sequencer	43
CW / WINKEY TAB	44
CW MESSAGES TAB	45
FSK MESSAGES TAB	46
DVK TAB	47
KEYBOARD TAB	48
Using The FH-2 (RESPAD) Input For Simplified Device Control	51
DISPLAY TAB	52
SYSTEM SETTINGS TAB	53
13 - ROUTER MENU ITEMS DESCRIPTION	54
ROUTER MENU	54
PRESET MENU	55
DEVICE MENU	56
VIRTUAL PORT MENU	57
Cables & Bridges	58

HELP MENU	59
14 - SYSTEM CONSIDERATIONS	59
15 - HARDWARE SPECIFICATIONS	60
16 - PACKAGE CONTENTS	61
17 - WARRANTY	61
DECLARATION OF CONFORMITY	62
APPENDIX A – CONNECTORS	63
APPENDIX B – RFI Considerations	65

1 - FEATURES AND FUNCTIONS

General:

- ⑩ Single USB connection to computer
- ⑩ Standalone operation
- ⑩ Complete "Computer ↔ Transceiver ↔ Amplifier" galvanic isolation
- ⑩ **Internal 24-bit USB Audio**
 - ⑩ *Standard USB Audio Class device – no custom driver required*
 - ⑩ *Asynchronous data transfer, internal low phase noise LO: -145dBc/Hz @1kHz*
 - ⑩ *High dynamic range: 110 dB typical, 105 dB minimum*
 - ⑩ *Simultaneous audio input devices for Line and Microphone Input*
 - ⑩ *Extremely low noise floor: as low as <10 μV effective*
 - ⑩ *Additional S/PDIF Optical audio input/output ports*
- ⑩ iLINK port for digital connection to iLINK enabled devices for frequency and data exchange
- ⑩ Real-Time audio levels monitoring on built-in color OLED display
- ⑩ Silent switching of all audio signals without relays
- ⑩ DSP for all analog signals, including microphone inputs
- ⑩ Compatible with most Windows based logging and control programs

Radio control (CAT):

- ⑩ Two, managed (CAT protocol controlled) CAT ports for connecting two loggers or control programs at the same time
- ⑩ Up to 57600 Baud with handshake support
- ⑩ Integrated level converter for CI-V, FIF-232, IF-232, or RS-232 levels
- ⑩ Supports most Elecraft, Icom, Kenwood, Ten-Tec, Yaesu and other radios
- ⑩ Simplex SDR receiver tracking feature (Kenwood and Icom protocol support)

Voice (SSB/AM/FM):

- ⑩ Two microphone support for headset and hand/desktop mic
- ⑩ Fixed or automatic microphone selection
- ⑩ Menu driven settings, no jumpers and trimmers
- ⑩ Individually adjustable Gain, Bias, Tone Emphasis and ALC supports seamless use of electret and dynamic microphones combinations
- ⑩ Individual "Voice" monitor loopback for "TX Audio recording"
- ⑩ *Digital Voice Keyer with nine messages per bank, up to 120 seconds each, unlimited number of banks*

Digital (FSK/AFSK):

- ⑩ 24-bit, high dynamic range, very low distortion analog inputs
- ⑩ Dual channel receive capability
- ⑩ Ultra low noise floor for optimal decode level
- ⑩ Front panel transmit and receive level control knob
- ⑩ Separate Data PTT output for digital audio modes operation (AFSK) with microphone muting
- ⑩ True analog feel, low latency RTTY tuning indicator (crossed ellipses)
- ⑩ UART based, zero jitter FSK output
- ⑩ Re-sampled computer standard 45.0 Baud rate for accurate 45.45 Baud HAM RTTY speed
- ⑩ Intelligent diddle stuffing for no random gaps between characters
- ⑩ Supports data codes with 5/6/7/8 data bits and 1/1.5/2 stop bits
- ⑩ Sample accurate support for audio based P-FSK keying

- ⑩ Unique, hot switch protected FSK keying
- ⑩ Adjustable FSK keying polarity
- ⑩ PS/2 keyboard or keypad support for stand alone FSK transmission with type ahead function
- ⑩ Nine (9) user programmable FSK memories

CW:

- ⑩ Genuine WinKey™ version 3 chip
- ⑩ Front panel speed knob
- ⑩ Selectable side tone for external speaker with "paddle side tone only" function
- ⑩ Individual side tone for "TX Audio recording"
- ⑩ Sample accurate support for audio based Q-CW keying
- ⑩ PS/2 keyboard or keypad support for stand alone CW "memory keyer" with type ahead function
- ⑩ Nine (9) user programmable memories
- ⑩ Logger independent contest auto-numbering (Field Day style)

Other:

- ⑩ 1 Watt amplifier for monitor/sidetone
- ⑩ OLED main display
- ⑩ Isolated, high voltage optoMOS based PA and LNA keying outputs, no clicking relays
- ⑩ CI-V output for controlling CI-V compatible Power Amplifiers or other accessories
- ⑩ Serial output for controlling stepper motor based antennas
- ⑩ User presets to recall all parameters for different logger or control programs
- ⑩ Optimized for future "Remote Control Suite – Server" connection
- ⑩ Huge filtering for maximum RFI immunity
- ⑩ Metal/Aluminum case, powder coated and silk screened
- ⑩ Free, no time limit firmware/software upgrades via Internet

2 - IMPORTANT WARNINGS

ALWAYS check the polarity of the 13.8 V power supply.

If you use micro KEYER III with more than one transceiver, ALWAYS be sure the proper microphone is connected to the RJ45 jack BEFORE connecting the RADIO interface cable.

If your radio includes upgradeable firmware DO NOT perform any upgrade through micro KEYER III.

Remember, under Windows, microHAM USB Device Router must be running anytime the interface is used (not just for setup). If Router is not running, the device cannot be accessed!

3 - PANEL DESCRIPTION

Front Panel

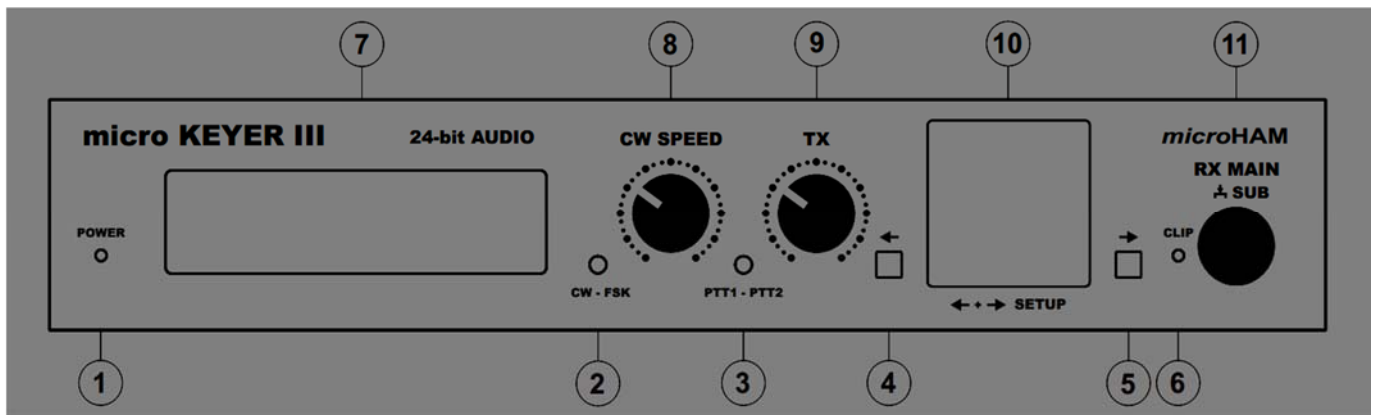

1. POWER

LED lights when +13.8V is applied (power switch on). Flashing in Stand-by.

2. CW/FSK

LED flashes in red color with CW output.

LED flashes in green color with FSK output.

3. PTT1/PTT2

LED lights in red when PTT1 (transceiver microphone connector) is active.

LED lights in green when PTT2 (transceiver accessory/data connector) is active.

4. ←

Left button for setup and OLED screen navigation.

5. →

Right button for setup and OLED screen navigation.

Invokes and closes SETUP menu when pushed together with left button.

6. CLIP

LED flashes when any audio signal is clipping (signal is too strong).

7. LCD

Status LCD display.

8. CW SPEED

WinKey speed control. Range (MIN, MAX) is defined by software.

9. TX

Audio output level to transmitter.

10. OLED

Signal level monitor display.

11. RX MAIN/RX SUB

Audio input level from Main Receiver (left channel) to the codec. Pushed and turned sets audio level from Sub Receiver (right channel) to the codec.

Knob sets parameters and on/off functions (push) in setup.

Rear Panel

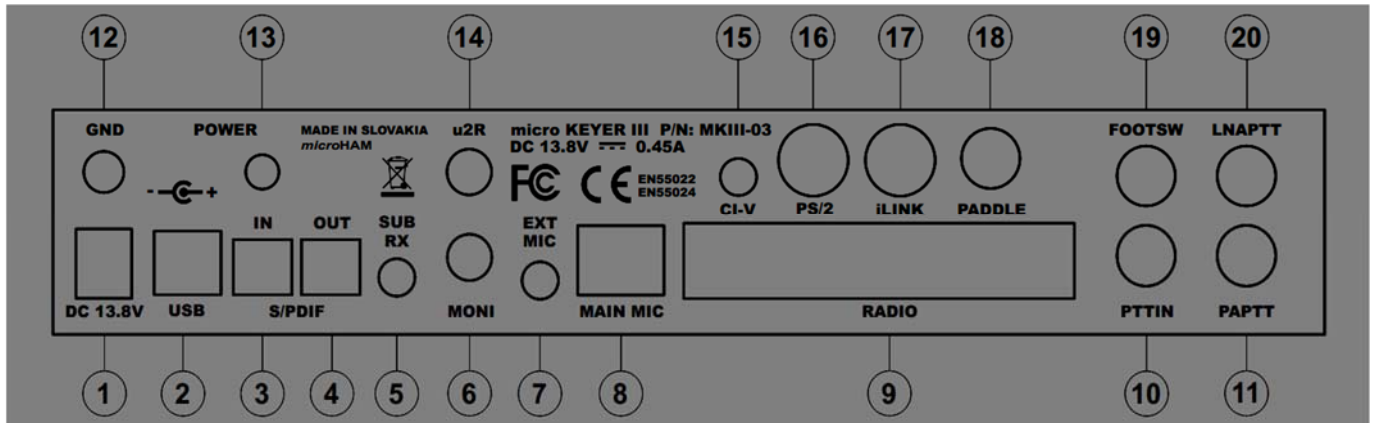

1. DC 13.8V

Power Supply - 2.1 x 5.5 mm coaxial jack, center is positive (+).

WARNING: Be sure to observe the proper polarity!

2. USB

USB B connector for computer connection. Uses standard USB A-B cable.

3. S/PDIF IN

S/PDIF input from transceiver. Uses standard Toslink cable.

4. S/PDIF OUT

S/PDIF output to transceiver. Uses standard Toslink cable.

5. SUB RX

Audio input from transceiver (second receiver - right channel).

Connector: 3.5mm (1/8") TIP = Signal, RING = N/C, SLEEVE = Ground

6. MONI

TX monitor speaker connection.

Connector: 3.5mm (1/8") TIP = Speaker +, RING = Speaker -, SLEEVE = N/C

7. EXT MIC

Connection for headset microphone.

Connector: 3.5mm (1/8") TIP = Signal (+Electret Bias), SLEEVE = Ground

8. MAIN MIC

OEM station microphone (original). Connector: RJ45 female

9. RADIO

DB37F connector for radio interconnections. See Appendix A for details

10.

PTT IN

Connects transceiver PTT OUT (Send). Used for sensing when transceiver has been switched to transmit by VOX, MOX or by CAT PTT.

Connector: RCA TIP = Signal, SHELL = Ground

11. PA PTT

PTT output for Power Amplifier. Active output goes to ground.

Connector: RCA TIP = Signal, SHELL = Ground

12. GND

Terminal for connection to station ground.

13. POWER PADDLE

Power Switch

14. u2R

Audio output for microHAM micro2R two radio SO2R controller.

15. CI-V FOOTSW

Auxiliary CI-V output for controlling external devices using Icom transceive protocol

Connector: 3.5mm (1/8") TIP = Signal, RING = N/C, SLEEVE = Ground

16. PS/2

MiniDIN6 for the PS/2 keyboard or PS/2 keypad.

17. iLINK

MiniDIN6 for iLINK connection to the iLINK enabled device.

18. PADDLE

CW Paddle connection.

Connector: 6.3mm (1/4") TIP = Dit, RING = Dah, SLEEVE = Ground

NOTE: [The paddle sense can be reversed using Router settings](#)

19. FOOTSW

RCA foot switch input. Active when closed to ground.

Connector: RCA TIP = Signal, SHELL = Ground

20. LNA PTT

PTT output for controlling Low Noise Preamplifier or Receive antenna switching.

Active polarity is set in the Router.

Connector: RCA TIP = Signal, SHELL = Ground

4 - HARDWARE INSTALLATION ... part I

Cables Connection

Installation of MKIII consists of hardware and software part. First, it is necessary to setup hardware part.

1. Turn off the radio and make the rear panel of micro KEYER III accessible.
2. Plug the DB37M of the radio cable set into the RADIO connector on the rear panel of the MK III. Connect ALL connectors from the cable set to the matching jacks of your transceiver.
3. If your transceiver has dual receivers (FT-1000D, 1000MPxx, 2000, 5000, 9000, Orion, IC-7800, 7851, K3, K3S, TS-950, 990 etc.) connect the fixed level audio output from the second receiver to the SUB RX jack using the supplied patch cable. Sub receiver output is always located on 1/8" female pigtail outgoing from main receiver plug.
4. Connect the station microphone to the RJ45 MIC jack. If your microphone has a Foster (round) connector, use the supplied adapter. Do not reverse spiral cable on Yaesu desk microphones, always use it as designed for your type of transceiver and use supplied RJ45-Foster 8 adapter if necessary!
5. Connect your paddles to the PADDLE jack.
6. If you use a foot switch, connect the foot switch to the FOOTSW jack.
7. Connect your transceiver PTT output (TX GND, SEND, LINEAR etc ...) to the PTT IN jack using the supplied RCA to RCA cable.



Optional: For Icom transceivers, open MK III and install the ICVOX jumper located behind the PTT IN jack to close both pins. Jumper replaces above connection. Applicable **ONLY** for Icom transceivers!
Default factory setting is open jumper (as shown on photo).



8. Connect a 13,8 to 16V DC supply to the DC 13.8V jack.
Be sure to observe the proper polarity!

IMPORTANT: DO NOT use the same power supply as the transceiver.

Optional: If your transceiver's accessory port is capable of supplying +13.8V at 800 mA in peaks, you may install the **DB37** Power jumper located in the right rear corner just in front of the +13.8V DC jack to short middle and right pins. MKIII gets power by DB37 cable leads, DC 13.8V jack is not used. Default **MAIN** position shorting middle and left pins sets DC 13.8V jack as power input (as shown on photo).

NOTE: Most Icom radios are capable providing 13.8V at 1000 mA on its ACC jack. Most other brand radios do not. DO NOT move jumper to use DB37 Power input with Yaesu transceiver which has fused 200mA output current limit (replacing fuse isn't fun) or if the Accessory power is less than 13.8 Volts when transmitting (e.g., Elecraft K3).

9. Locate but **DO NOT** connect the USB cable to the MK III at this time.
10. Turn MKIII ON by flipping rear panel power switch or by turning on transceiver.

OLED Screen Description

OLED display of MKIII provides real time information about levels and state of the internal audio. Real time screens can be changed by ← → buttons next to display. Additional screens are providing tuning indicator for RTTY, while top status area remains on its position.



1. Receive audio source indicator.

If receive audio is taken from analog line output of connected transceiver display shows LINE. If audio is taken from optical output of transceiver display shows S/PDIF. Switching between LINE and S/PDIF is automatic, based on presence of optical data stream. If optical data are not present or not in required format, MKIII input receives audio from LINE input.

2. Receive audio sampling rate.

Shows sampling rate chosen on host computer for line input of MKIII sound card. Format is “bit depth” / “sample rate”. For example 24/96 means 24bit audio data sampled at 96000Hz.

IMPORTANT: If you are using S/PDIF optical input and shown number is in red color instead

white, it means that chosen sampling rate or bit depth on computer is not supported by transceiver. Please refer to your transceiver manual to check available sampling rates or change sampling on computer until display shows white numbers.

3. Receive audio signal level.

Two stacked real time VU-meters show receive signal level going to stereo line input of internal sound card, and from there to the attached computer as stereo signal on line input channel. Top meter shows main receiver signal level (left audio channel), bottom shows sub receiver signal level (right audio channel). This input is generally used as signal source for digital modes programs or as a source for contest audio recording.

NOTE: These meters don't move until computer is taking audio from line input of the MKIII's built-in sound card. If you don't see them moving, computer is not receiving audio data.

4. Receive audio gain knob position.

Two stacked indicators shows position of digital gain knob. Strip is shown in white color when gain is set to 0dB. Changes color to magenta when gain is positive, or to cyan when gain is set to negative value (attenuation). Top indicator shows gain position for main receiver, bottom for sub receiver.

5. Microphone level to computer.

Real time VU-meter indicates microphone signal level going to microphone input of internal sound card, and from there to the attached computer as signal on microphone input channel. This input is generally used as signal source for DVK messages.

6. Microphone input recording indicator.

Shows R-MIC label in green color when computer is taking audio (recording) from microphone input channel of internal MKIII sound card. Recorded audio contains only signal from microphone attached to the MKIII, either MAIN MIC or EXT MIC jack.

7. Active RX audio data indicator.

RX label goes green when attached computer is taking audio from line input of the MKIII's internal sound card. When audio data are not taken, indicator is grey.

NOTE: This indicator well serves as first hand troubleshooting help because it must go green when digital modes program or contest audio recorder is started and principally indicates that this program has correct audio input device selected.

8. Active TX audio data indicator.

TX label goes red when attached computer is sending audio to line output of the MKIII's internal sound card. When audio is not sent, indicator is grey.

Indicator well serves as first hand troubleshooting help because it must go red when TX on digital modes program or DVK is initiated.

9. Transmit audio signal path.

Label shows active audio switching path inside the MKIII. It contains two parts, source and destination separated by → arrow.

MM → M, signal from MAIN MIC goes to MICROPHONE jack on transceiver

EM → M, signal from EXT MIC goes to MICROPHONE jack on transceiver

PC → M, signal from the computer goes to MICROPHONE jack on transceiver

PC → L, signal from the computer goes to LINE input on transceiver

TT → M, internal test tone of the MKIII goes to MICROPHONE input on transceiver

TT → L, internal test tone of the MKIII goes to LINE input on transceiver

10. Computer generated transmit audio level to radio.

Real time VU-meter indicates audio signal level generated by computer, delivered either to the microphone or the line input on the attached transceiver, according to active signal path described above.

11. Transmit audio level to radio.

Real time VU-meter indicates audio signal level delivered either to microphone or line input on the attached transceiver. This VU-meter indicates level of any audio signal sent to radio, including signal from microphone, not only computer generated audio as above.

12. Transmit audio gain knob position.

Bar indicates position of front panel TX gain knob. Knob adjusts modulation audio level of any audio signal going to the attached transceiver and its relative-to-preset level position. Level of gain or attenuation is also shown as positive or negative number in dB and changes color to magenta (gain), white (zero gain) or cyan (attenuation).

13. Microphone input level.

Real time VU-meter indicates active microphone signal level. Microphone gain can be adjusted in menu.

14. Main RX input level.

Real time VU-meter indicates input level of the signal coming from main receiver. Level indicator is similar to the status bar VU-meter (3), but shows signal all the time, even if computer is not attached.

15. Main RX gain knob position.

Bar indicates position of front panel main RX MAIN gain knob. Knob adjusts main receiver signal level delivered to the computer providing larger readout as position in the status bar (4). Level of gain or attenuation is also shown as positive or negative number in dB and changes color to magenta (gain), white (zero gain) or cyan (attenuation).

NOTE: Knob sets digital gain or attenuation of the main RX signal going to computer. It does not change amplitude of the receive signal coming from the radio, it must be set in transceiver menu.

16. Sub RX input level.

Same as (14) but indicates signal coming from sub receiver of the attached transceiver.

NOTE: Sub receiver audio is connected to the MKIII separately by supplied 3.5mm patch cable, connecting SUB RX jack of MKIII to 3.5mm female jack located on pigtail on specific DB37 cable.

17. Sub RX gain knob position.

Same as (15), but to adjust sub receiver signal level, you have to push and turn the knob.

Clipping

Before we continue to initial HW setup of the MKIII, it is important to explain and realize important fact of digital audio signals processing. MKIII process all audio signals digitally, it means that analog signals are first converted to digital signals by A/D (analog to digital) converters, then are processed by built-in DSP controller, and then are either sent to the computer or converted back to analog by D/A (digital-to-analog) converters and sent to the transceiver. This DSP process requires that no analog signal is stronger than is the limit of converter. When this happens, peak of analog signal is cut and digitized signal is distorted (contains lot of harmonics). This effect is called “clipping”. To be aware of clipped signal, MKIII has dedicated front panel led marked CLIP, item (6) at front panel description. Led shortly flashes when any audio signal going through MKIII gets clipped.

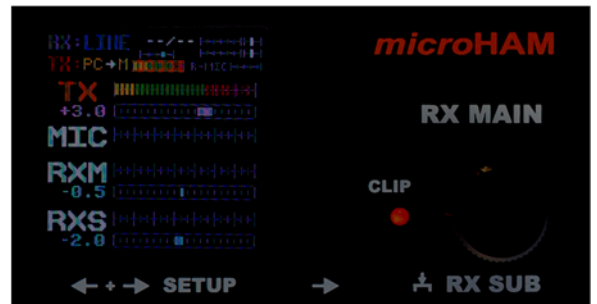

MKIII recognizes two kinds of clipping, hardware and software. Hardware clipping occurs when audio input signal from microphone or transceiver is too strong or when level of the output signal is too high and contains clipped parts. When this happens, OLED display shows clipped signal on VU-meter with red background and changes VU-meter label (TX, MIC, RXM, RXS) to red color too. Problem can be easily fixed by decreasing the microphone gain in MKIII SETUP 1.1/1.4 or by decreasing receive audio output level in the transceiver menu. Software clipping occurs, when you set gain of transmit or receive signal too high and DAC or USB upstream is fed with clipped samples. Software clipping is indicated in the same way as hardware clipping, but color of the background and labels is orange. When it happens, decrease TX or RX gain by front panel knobs.

5 - HARDWARE INSTALLATION ... part II

Microphones Setup

Assuming you've connected all cables as described in HARDWARE INSTALLATION chapter, you can proceed to initial hardware SETUP.



Rotate to change

To enter SETUP menu, push LEFT and RIGHT arrow buttons located on both sides of the OLED display together.

Do the same when you will want to leave the SETUP menu.

Push together to enter or exit SETUP

by num between screen, you can change shown parameter by rotating RX MAIN knob. Pushing knob changes setting shown on the bottom of the screen, like BIAS ON/OFF. This logic applies to all setup screens.

For further steps, please use dummy load or setup on dead band to not cause QRM to other HAMs.

Setup 1.1 MAIN MIC GAIN



This setup screen serves for adjusting microphone gain attached to MAIN MIC jack. If attached microphone element is electret (all Icom radios have electret OEM microphone), push the knob to turn required BIAS ON. MKIII provides 8VDC bias on microphone pin as is standard for this kind of microphones. If you attached MAIN MIC is dynamic, keep BIAS OFF. Now speak to microphone as you normally speak to mic and adjust gain by rotating the knob. Set it for maximal signal swing with peaks in red area, but avoid clipping.

IMPORTANT: If you have attached both MAIN and EXT MIC to the MKIII, EXT MIC has priority. You have to push PTT button on MAIN MIC to focus MAIN MIC or unplug EXT MIC during MAIN MIC settings.

Setup 2.1 MIC DRIVE LEVEL



Now please set radio to either USB or LSB mode. This setup screen sets output modulation level for VOICE mode when signal source is microphone. Press PTT button on hand/desk microphone or push knob (if EXT MIC is disconnected) to key the radio. Speak to microphone and by rotating the RX MAIN knob set proper driving level by watching ALC meter on the radio. ALC should nicely move within its range during normal speech. Do not overload ALC

above specified range.

If MKIII does not know mode of your transceiver, you'll see CW/MIC mode routing. Once your MKIII is setup for CAT decoding, you'll see VOICE/MIC mode routing. Just to avoid confusion, level for both routing is the same.

At this point you should have basic microphone setup done, you can return back to Setup 1.2.

Setup 1.2 MAIN MIC ALC



Microphone inputs on MKIII have special ALC amplifiers, please note, it is a different ALC circuit than ALC in your transceiver. Microphone ALC amplifier in MKIII dynamically sets attenuation to microphone signal by tracking its signal and if signal is too strong, applies attenuation proportionally. If you are used to speak too loud occasionally, you can turn ALC ON. ALC gain sets initial gain of the amplifier, default value of 60 is good starting point, it has roughly 0dB gain and sets attenuation down to 30dB. Higher value rises gain (and noise), lower decreases gain. ALC timing is not affected by ALC gain and is adjusted for human voice.

Setup 1.3 MAIN MIC TONE



Each microphone input on MKIII has its own simple equalizer for basic correction of microphone characteristic. By pushing knob you can tun it ON and by rotating knob emphasize either lower or higher frequencies. By emphasizing lower frequency your signal will sound more full, broadcast like but communication efficiency will be lower, you'll be consuming RF power to sound nice. By emphasizing higher frequency, you'll rise intelligibility of your voice as low frequencies do not carry a lot of information but you won't sound like broadcast station.

You can now plug-in headset to EXT MIC jack and repeat settings for EXT MIC.

Please note, you shouldn't need to change MIC DRIVE LEVEL in menu 2.1, it is already set.

Setup 1.4 EXT MIC GAIN



At this setup screen you set up microphone gain for microphone attached to EXT MIC jack. If attached microphone is electret, turn BIAS ON and MKIII will provide 2.5VDC bias on TIP of jack. Ring is not used, if your electret microphone requires bias on ring, use mono to stereo adapter, mono side to EXT MIC jack on MKIII. If you are using headset with dynamic microphone, keep BIAS OFF. Now speak to microphone as you normally speak to mic and adjust gain by rotating the knob. Set it for maximal signal swing with peaks in red area, but avoid clipping.

Setup 1.5 EXT MIC ALC

This screen sets ALC, same as setup screen 1.2 but for EXT MIC microphone.



Setup 1.6 EXT MIC TONE

This screen sets equalizer, same as setup screen 1.3 but for EXT MIC microphone.



At this point you should have both MAIN and EXT microphones set, nicely driving the radio. For other settings you'll need to setup computer first, you'll be instructed later. Please proceed to next few settings.

Setup 4.1 RTTY



MKIII features RTTY tuning indicator. If you are RTTY operator, you may find useful to have hardware based "crossed ellipses" from vintage times. This screen allows you to set RTTY tones low 1275Hz/1445Hz pair or to high 2125Hz/2295Hz pair. By rotating knob you can enable indicator for MAIN RX, MAIN and SUB RX in separate screens and finally interlaced MAIN + SUB RX on one screen. In this last settings, MAIN RX indicator is in green color, SUB RX is yellow. Now you can leave the setup by pushing LEFT and RIGHT buttons together. Switch to RTTY tuning screen by RIGHT (or LEFT) button, find some RTTY signal and test RTTY tuning.

Rest of settings, levels for computer generated audio we cannot setup now, instructions need prior understanding of audio routing and are described later in COMPUTER AUDIO LEVELS SETUP chapter.

6 - micro KEYER III SOFTWARE INSTALLATION

Software installation for MKIII contains three parts, installation of the FTDI driver, installation of the MKIII configuration tool (USB Device Router) and configuration of the MKIII's internal sound card. FTDI driver installation is required only on macOS computers, on Linux are FTDI devices supported by OS core, on the Windows OS it is installed automatically by provided USB Device Router. Installation and configuration of the control program and USB Audio devices will be described separately for each operating system.

Understanding USB Audio in the micro KEYER III

USB Audio device built-in to the micro KEYER III serves for several functional requirements: to send TX audio from the computer to the transceiver, to get transceiver's receive audio to the computer and to record microphone audio to the computer. To accomplish these tasks, MKIII provides three independent audio paths, one downstream and two upstream paths.

Downstream (playback) audio path (from the computer to the MKIII) is used as TX audio modulation source for transceiver, either from any audio based digital modes operation program for RTTY, PSK31, FT8, etc. or as an output from Digital Voice Keyer (DVK) for SSB. Downstream path is stereo, but only left channel contains audio modulation data. Right channel audio data can be optionally used as P-FSK (RTTY) or Q-CW (CW) keying source if digital modes program supports this keying methods. Analog output from this downstream (playback) path can be connected either to a microphone jack of the transceiver, desirable for DVK operation in SSB where you want to pass signal thru microphone processing blocks in the transceiver (compressor, TX equalizer, etc ...) or to the Line input of the transceiver, as is necessary for digital modes operation where you must bypass all audio processing blocks in order to have undistorted, maximally clean and linear output signal. Most transceivers switch these two inputs automatically according to the selected operating mode, Microphone input for USB, LSB, AM, FM, and Line input for USB-D, LSB-D, PKT, DIG, DATA modes. MKIII monitors transceiver's mode by CAT connection and switches playback audio to the proper input accordingly. In addition to these analog connections between MKIII and transceiver, MKIII is also supplying playback audio in digital S/PDIF format in parallel with analog, using optical Toslink port to S/PDIF enabled transceivers, preserving original audio source quality and bypassing D/A (digital to analog) conversion.

On the opposite way from the transceiver to the computer, MKIII features two independent upstream (recording) paths working simultaneously. On computer, these paths are recognized as two separate recording devices. First upstream path is a mono audio path, sourced from the microphone attached to the MKIII and always carries microphone audio. Normally this path is used as an audio input (source) for DVK.

Second upstream (recording) path, is a stereo audio path carrying receive audio from MKIII to the computer. When MKIII is connected to the transceiver with two receivers, Main RX audio is provided in the left channel of the upstream, Sub RX audio in the right channel. MKIII uses transceiver's constant level analog Line outputs as an audio source for this upstream path, but can also connect to the digital audio S/PDIF data over optical Toslink connection. Switching between analog and digital (SPDIF) is handled automatically in MKIII and uses same upstream path.

In general, this upstream audio path is used as an audio source for all digital modes operation programs and as a source for both RX and TX contest audio recording. Transmit audio replaces Main RX audio during TX.

USB audio in micro KEYER III is *USB Audio Class* compliant device. These devices are natively supported by all current operating systems (Windows, macOS, Linux) and are recognized automatically when plugged to the USB jack, thus audio installation process on computer does not require installation of any drivers, just setup (optimization) described in further chapters.

7 - macOS INSTALLATION

1. Use your web browser to go to <http://www.ftdichip.com/Drivers/VCP.htm> and download the latest driver image for proper version of your OS.
2. Open dmg package by clicking on it and follow the instructions to install.
3. Plug in the USB cable.
4. Turn on the radio or external power supply.
5. Configure MKIII Audio devices.

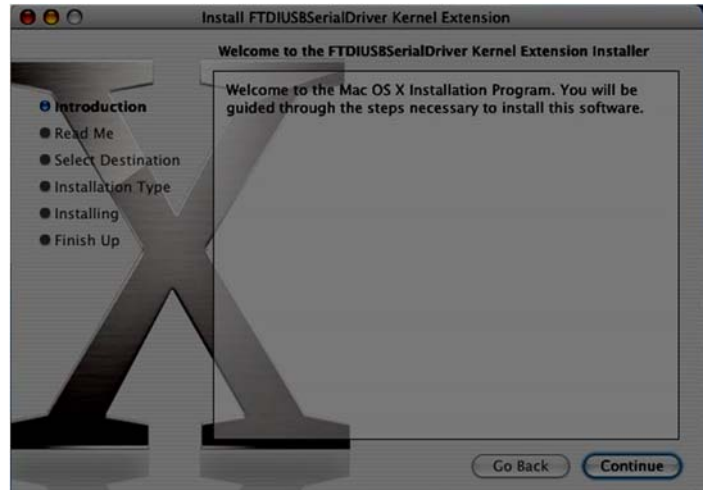

6. See configuration Setup Guides for further MKIII configuration under macOS and specific app.

NOTE: microHAM does not provide MKIII configuration tool for macOS, but thanks to our friends developing applications for macOS, MKIII can be well used with supported programs. Please check Downloads section on www.microham.com for links to authors and Support section for Setup Guides.

macOS USB Audio Setup

To set MKIII audio on macOS, please open Audio and MIDI Setup. At the left you will see two MKIII devices.

Select first MKIII device with 1 in / 2 outs. Input of this device is always connected to either the MAIN or EXT MIC microphone input on MKIII. MKIII shows level of signal arriving to this input on VU-Meter next to R-MIC label in the status area of the OLED display, described in OLED Screen Description chapter, items 5, 6.

Maximal sample rate for this mono input is 48,000Hz. Apps can use it for microphone audio recording, in general as an audio source for Digital Voice Keyer in SSB, assuming app supports such functionality. When app is taking audio from this input, R-MIC label on the OLED display changes color to from gray to green.

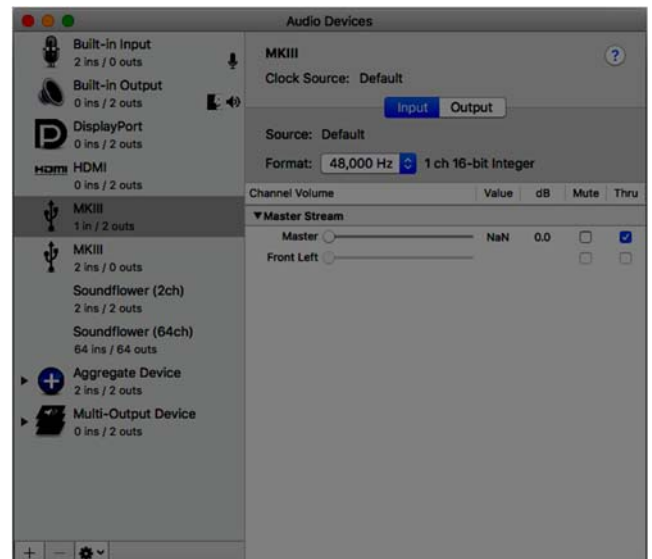

Output of this device is stereo and is used as a modulation source for connected transceiver in all modes. Maximal sample rate for output is 48,000Hz and output supports both 16-bit and 24-bit sample depth. Output signal level is shown on VU-Meter next to TX: sign, described in OLED Screen Description chapter, items 8, 10 in. Left channel carries audio modulation and level can be manipulated by TX knob on front panel. Right channel audio can be optionally used as Q-CW or P-FSK source for audio based keying (OOK) in CW and RTTY respectively. When app is sending audio to this output, TX: label on the OLED display changes color from gray to red.

NOTE: Software sliders on all MKIII audio devices have intentionally no function, all levels are exclusively set on MKIII front panel and in hardware SETUP. Their presence in Audio and MIDI

setup is only for keeping USB Audio Class requirements and USB implementation in Core Audio of macOS.

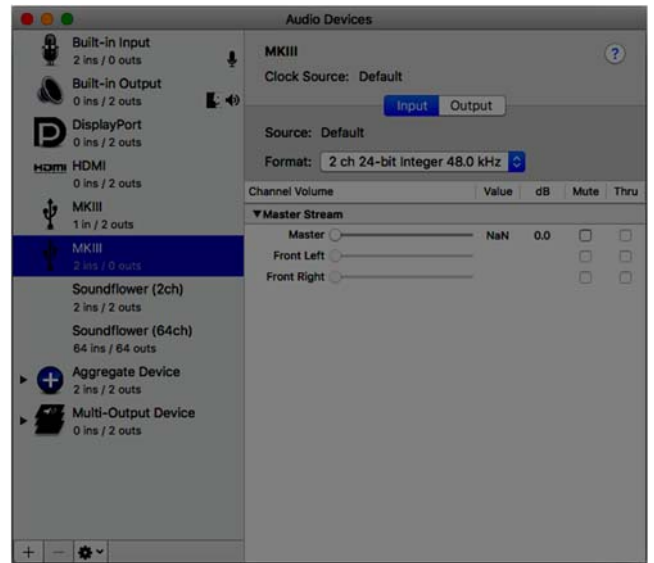
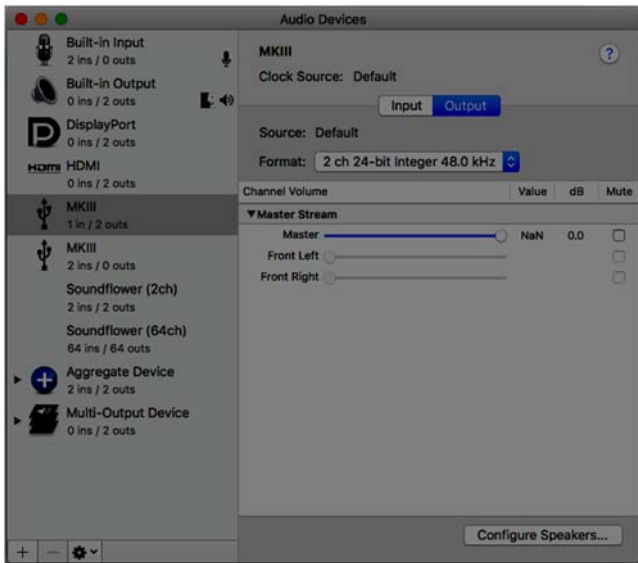

Second device with 2 ins / 0 outs is used for feeding computer with transceiver's receive audio, it doesn't have any output. Main receiver audio is connected to the left channel input, sub receiver audio to the right. Maximal sample rate is 96,000Hz and device supports mono mode for single receiver transceivers.

Receive signal level is shown on dual VU-Meter for each receiver separately, next to sample rate, see items 3, 7 in OLED Screen Description chapter. Level bought to this input can be manipulated by RX MAIN knob on front panel. When knob is pushed while turned, it manipulates level of sub receiver audio. When app is receiving from this input, RX: label shown on the OLED display changes color from gray to green.

8 - Linux INSTALLATION

Linux core since version 3.0.0-19 includes FTDI driver for our exclusive set of VID/PID numbers assigned by FTDI company to microHAM, thus there is no need to install any external drivers, neither for communication port nor for audio. In case your distribution doesn't have FTDI drivers installed, please visit <http://www.ftdichip.com/Drivers/VCP.htm> for download and installation instructions.

MKIII uses VID: 0x0403 PID:0xEEEF.

NOTE: microHAM does not provide MKIII configuration tool for macOS, but thanks to our friends developing applications for Linux, MKIII can be well used with supported programs. Please check Downloads section on www.microham.com for links to authors and Support section for Setup Guides.

Using mhuxd Router developed by Matthias DJ5QV, you can run virtually any Linux logger with MKIII.

Linux USB Audio Setup

Audio devices built-in MKIII are on Linux automatically recognized and shown in operating system. There isn't much to set as all parameters and sampling rate sets application using audio devices.

Microphone – MKIII input contains microphone audio and **is always connected to either the MAIN or EXT MIC microphone input on MKIII**. MKIII shows level of signal arriving to this input on VU-Meter next to R-MIC label in the status area of the OLED display. Maximal sample rate for this mono input is 48,000Hz. Applications can use this input for microphone audio recording, in general as an audio source for Digital Voice Keyer in SSB, assuming application supports such functionality. When application is taking audio from this input, R-MIC label on the OLED display changes color to from gray to green.

Line In – MKIII input carries transceiver's receive audio. **Main receiver audio is connected to the left channel input, sub receiver audio to the right**. Maximal sample rate is 96,000Hz. Receive signal level is shown on dual VU-Meter for each receiver separately, next to sample rate on OLED display.

Level bought to this input can be manipulated by RX MAIN knob on front panel. When knob is pushed while turned, it manipulates level of sub receiver audio. When application is receiving from this input, RX: label shown on the OLED display changes color from gray to green.

Analogue Output – MKIII is stereo output, used as a modulation source for connected transceiver in all modes. Maximal sample rate for output is 48,000Hz and output supports both 16-bit and 24-bit sample depth. Output signal level is shown on VU-Meter next to TX: sign. Left channel carries audio modulation and level can be manipulated by TX knob on front panel. Right channel audio can be optionally used as Q-CW or P-FSK source for audio based keying (OOK) in CW and RTTY modes respectively. When application is sending audio to this output, TX: label on the OLED display changes color from gray to red.

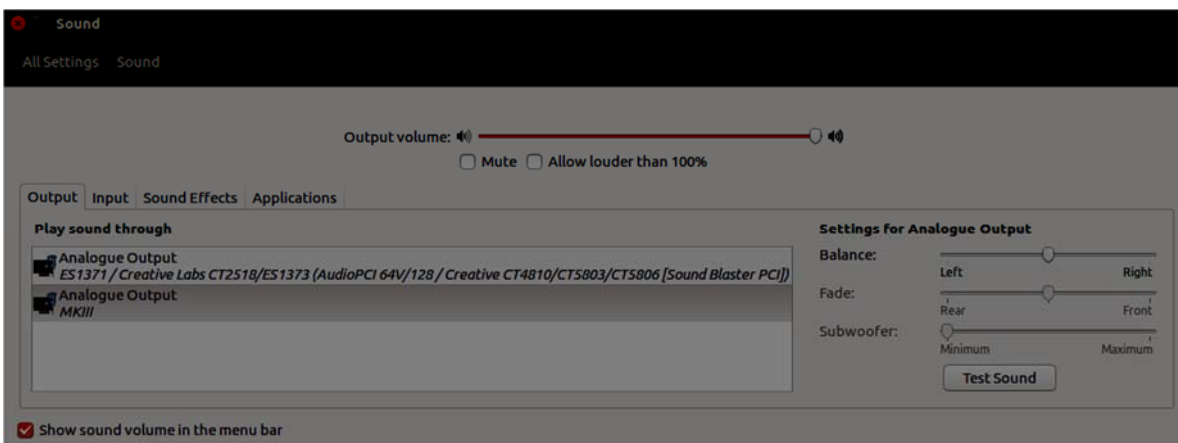
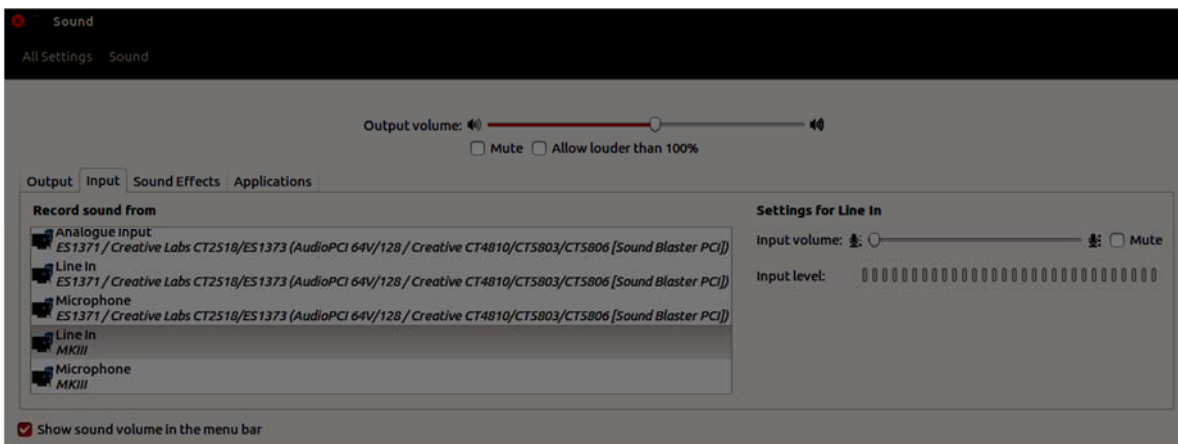

9 - Windows INSTALLATION

Operating MKIII on Windows computer requires installation and running USB Device Router (Router). Router is providing Virtual Serial Ports (VSP) based interface for logging or control programs running on computer, and advanced software setup tool for MKIII.

To install Router, download the most recent installation package from the web site: www.microham.com/contents/en-us/d29.html or go to www.microham.com and locate USB Device Router installation package at Downloads page.

Right click on "urouter_release_xx_xx.exe" (xx_xx is version) and choose **"Run as administrator"** to start the installation.

IMPORTANT: Failing to run installation package "as administrator" may lead to improperly installed Router with no access rights to registry.

The Windows setup utility will start and ask into which folder Router and its supporting files should be installed.

NOTE: Unless you have a very strong reason to install Router elsewhere, please accept the default location.

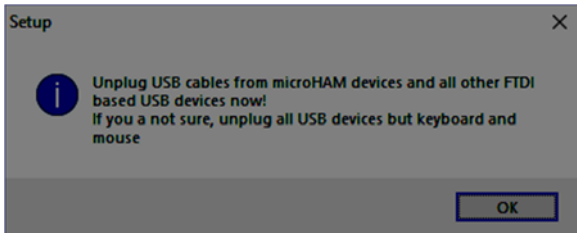
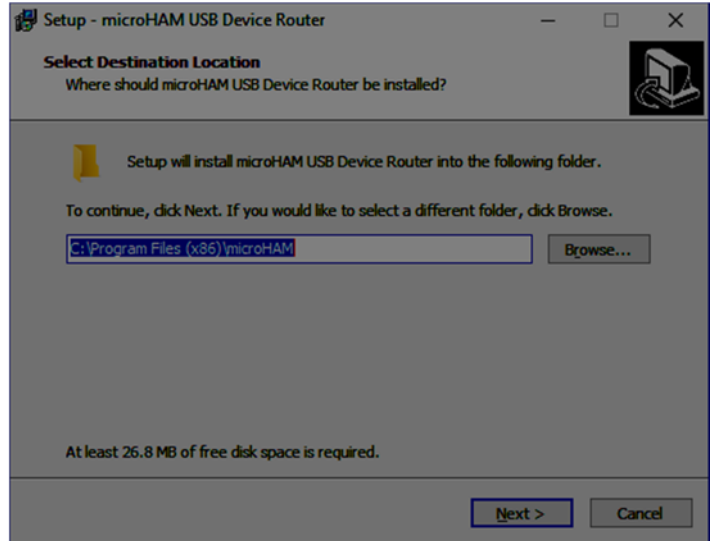

When the Router installation is completed, click "Finish" to launch Router for the first time. Plug in the USB cable.

WARNING: If you are installing MKIII on Windows XP computer, do not plug USB cable to the computer now. Push both arrow buttons on MKIII front panel at once to enter hardware SETUP. Push left or keep pushing right arrow button until you see SETUP 5.1 screen. Then



turn RX MAIN knob to see "COMPATIBLE with WinXP" mode shown on screen and CONFIRM selection by pushing the knob. Since USB cable was not plugged in yet, you don't need to restart computer as instructed. Push both arrow buttons at once to exit setup and plug the USB cable into the computer now.

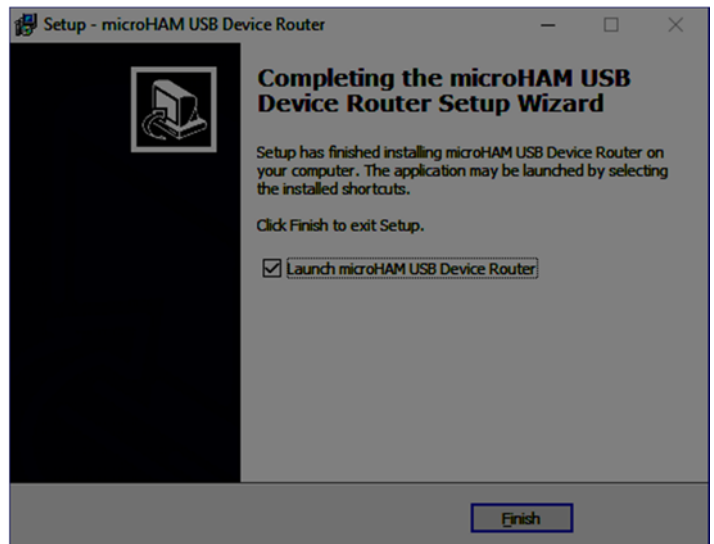

Windows USB Audio Setup

By default, Windows automatically sets any new audio device as the system default device for Sound Playback, Sound Recording and Communication. This is undesirable as all Windows generated sounds, browser and movie player audio would be played through micro KEYER III and onto the air!

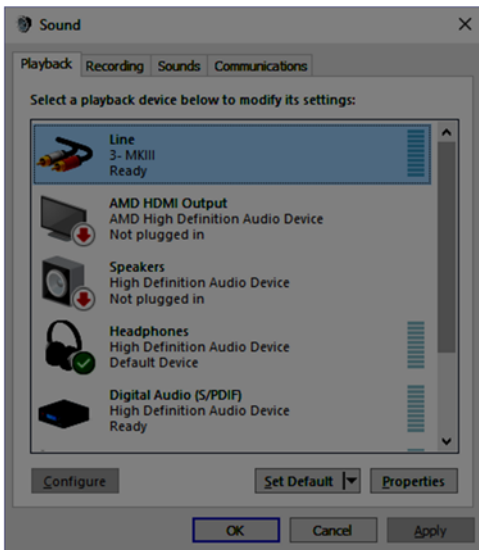

To return system sounds back where belongs, open "Sound" in the Control Panel or right click on the Speaker icon on the Taskbar and select "Sound Settings." Reset the Default device for Sound Playback and Communication to Speakers of your computer's primary sound device.

NOTE: If your computer's primary sound device is shown as "Not available" or "Not plugged in", insert a dummy plug to appropriate jack on computer. This makes it available for above settings.

Select "Line, MKIII" device and click Configure or double click on it and set proper settings on other tabs.

On **General** tab you can change name of the MKIII Line output device. Although it isn't necessary, we recommend to change it to more recognizable name. It will help a lot if you are going to use more than one MKIII on the same computer.

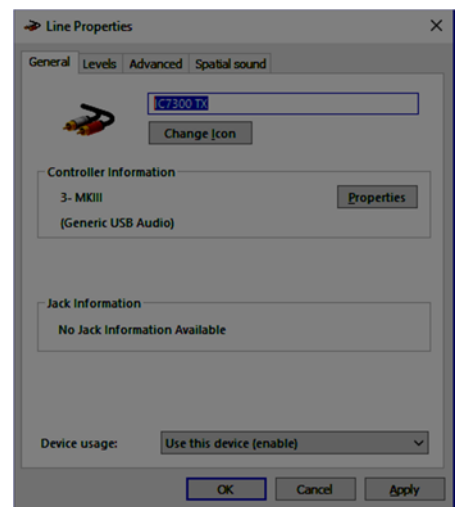

On **Levels** tab check if output is not muted. Slider position is intentionally **ignored** in MKIII firmware, its position **does not** change output level.

On **Advanced** tab check if output is set to 48000 Hz sampling rate.

On **Spatial sound** tab set all features to off.

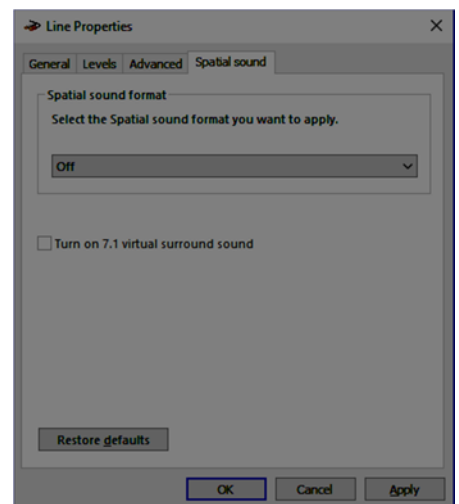
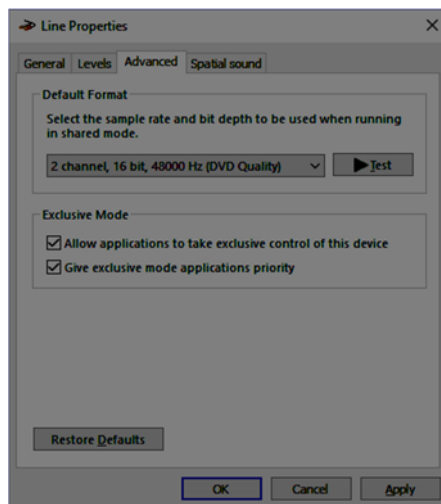
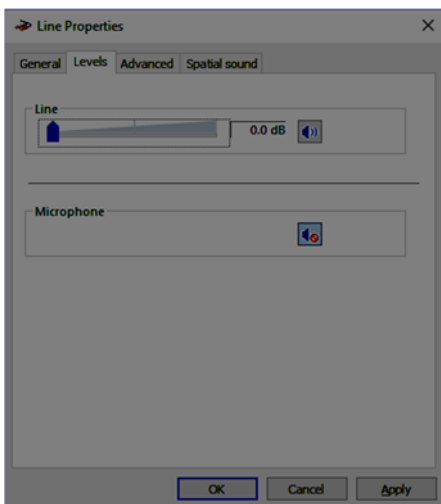

Now select “Recording” tab. Reset Default Device and Default Communications Device to a microphone input on the internal (primary) sound card in your computer. This sets your internal or external microphone attached to the computer default audio source for computer related communication programs like Skype or TeamViewer. Use “trick” described for Playback settings if device is “Not available” or “Not plugged in”.

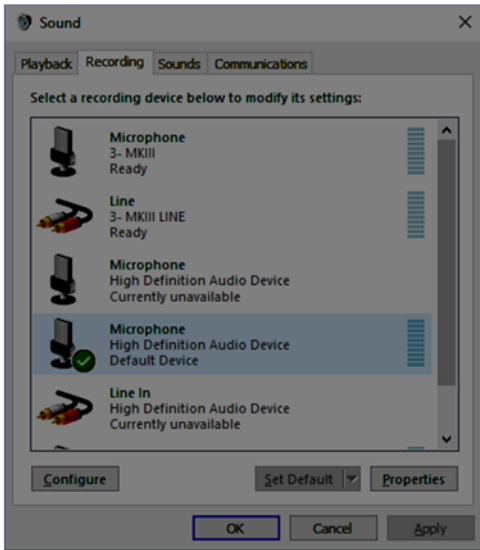

Select “Microphone, MKIII” device and click Configure or double click on it and proper settings on other tabs.

On **General** tab you can again change name of the Microphone input device as before.

On **Listen** tab do nothing.

On **Levels** tab check if input is not muted. Slider position is intentionally **ignored** in MKIII firmware, its position **does not** change microphone level.

On **Advanced** tab check if input is set to 1ch 16bit 48000 Hz sampling rate.

Click OK.

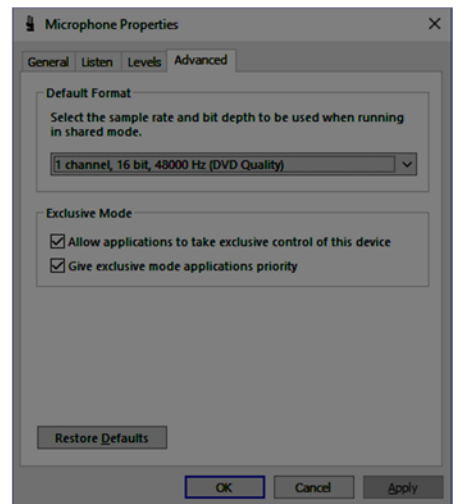
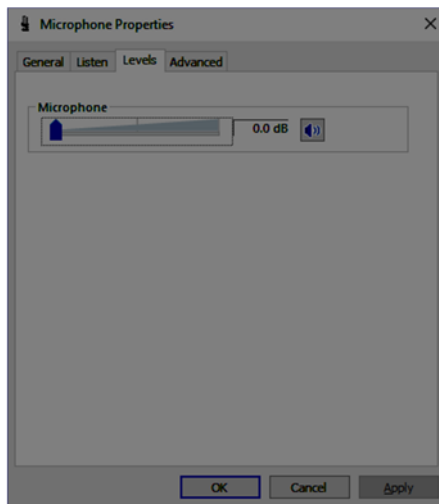
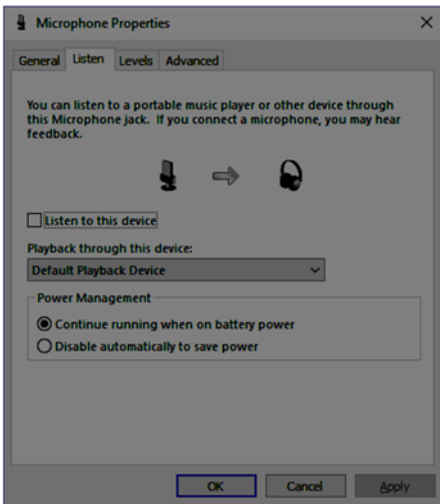

Select “Line, MKIII” device and click Configure or double click on it and proper settings on other tabs.

On **General** tab once again is possible to change name of the Line input device.

On **Listen** tab do nothing.

On **Levels** tab check if input is not muted. Slider position is intentionally **ignored** in MKIII firmware, its position **does not** change Line (receive) level.

Advanced tab is used to set base sampling rate from which is sampling rate derived to all application running on computer. If you have transceiver with two receivers connected to MKIII, select 2ch 24bit, 48000Hz. If you have capable computer, you can set 96000Hz sampling but make sure the MKIII is plugged directly to the computer's USB jack, because on external HUB you may not have enough bandwidth.

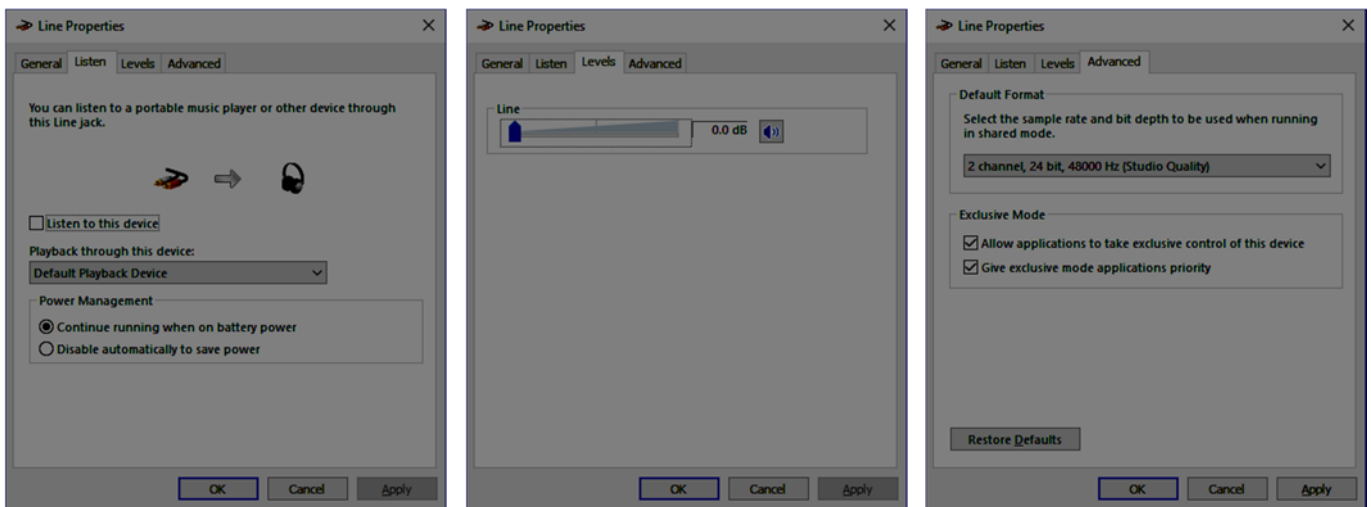

When you finish, you should end up with somewhat similarly looking Playback and Recording panes.

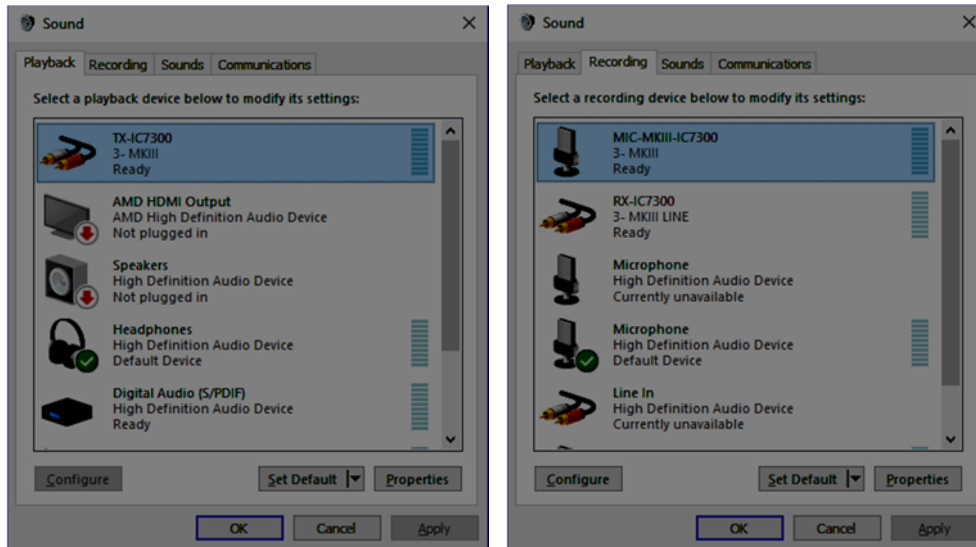

WARNING1: When you have Recording tab opened, Windows open all available sound cards at selected sampling and bit depth in order to show signal on small VU-meters. Active audio data flow to computer is also indicated by activating RX and R-MIC indicators on MKIII's OLED display. Please remember this Windows behavior as it may lead to false troubleshooting conclusions if this window is opened together with digital modes programs. Open it only when it is necessary.

WARNING2: If you are installing MKIII on Windows 10 computer, since OS update 1803, privacy restrictions may require user to enable input on audio devices. Setting is not worded much intuitive but means that you are allowing non Windows applications to use audio from input of all audio devices. If this setting is not enabled, no application other than from Microsoft will be able to process incoming audio. You must enable it in order to operate digital modes or use DVK. Go to Settings | Privacy | Microphone and set it ON.

10 - Configuring microHAM USB Device Router

The *microHAM* USB Device Router (Router) program provides a Windows compatible *configuration tool* for *microHAM* USB Devices (micro KEYER III as well as DIGI KEYER II, CW Keyer and USB Interfaces) and *software interface* to other Windows applications (logging software, digital mode software, etc.). The software interface is provided as *Virtual Serial Ports*.

In order to configure and use micro KEYER III with Windows compatible application programs, you must be running Router and have turned on micro KEYER III. Router is then configured as required by the application (logging, control or digital mode) software.

micro KEYER III Status

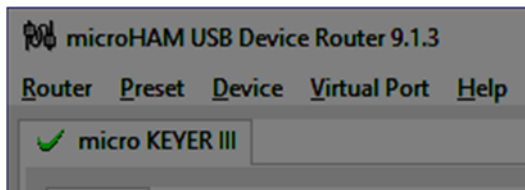

When the USB driver is installed correctly and micro KEYER III is turned on Router will show a device tab with a **GREEN** check beside the device name.

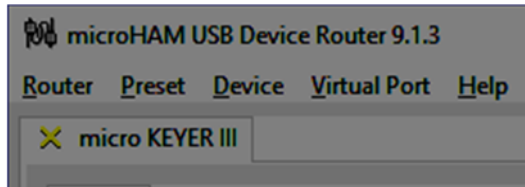

When Router shows a **YELLOW** "X" instead of a green ✓, it means that the Router doesn't see the responses from the micro KEYER III. If state persist, it is a sign of problem.

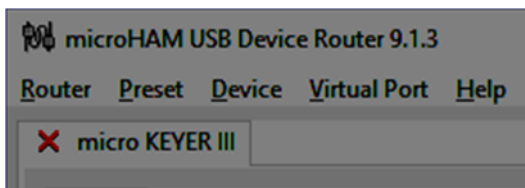

When Router shows a **RED** "X" instead of a green ✓, it means the micro KEYER III device is disconnected. This happens when the USB cable is unplugged or the USB driver is not correctly installed or if the micro KEYER III is turned off.

Troubleshooting:

Yellow sign is real problem, if persist try to replace USB cable as a first, try different USB socket on your computer, if you use external HUB, check its power or connection to the computer. If problem still persists, try to reset USB driver. Unplug USB cables from all microHAM devices and other USB devices which use or may use FTDI chip and go to the Router menu | USB tab and click Reset USB driver. If nothing above helps, last resort is to reset firmware. Procedure is: Turn MKIII OFF, push and hold right arrow button while turning MKIII ON. When CLIP led starts slowly flashing, release button. Click Device | Upload Firmware, select provided firmware file and click OK. CLIP led will flash rapidly as MKIII's firmware is being reflashed. If it won't help either, contact us.

11 - microHAM USB DEVICE ROUTER VIRTUAL SERIAL PORTS

microHAM Router provides a set of virtual serial ports which allow Windows applications (logging and digital software) to work with micro KEYER III just as they would work with "real" (hardware) serial ports. In order to use these virtual Ports, you must first create the ports and then assign a port to each function you wish to use (radio CAT control, PTT, CW, FSK, etc.). Virtual ports are created and deleted from the **Virtual Port** menu located on top Router's menu bar.

Create Port: Creates virtual COM ports. It is possible to select more than one port at a time by checking appropriate boxes. Creating virtual ports may take a long time (several tens of seconds), be patient.

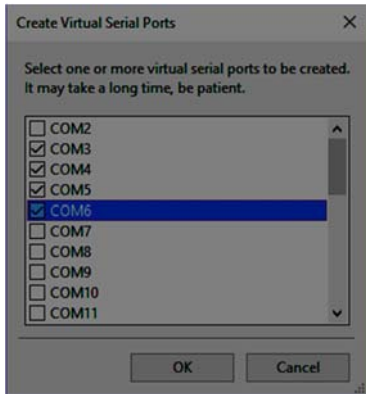

DO NOT define a port that is already in use (for example, COM1 or COM2 which are hardware ports on some motherboards) or a virtual port that is already used by another USB device. Even though Router will not allow creating a virtual port on a COM port number which is currently present in the system (like hardware COM ports or internal modems), sometimes these ports are hidden. If another device that also uses virtual ports (external USB devices, bluetooth devices, mobile phones, PDAs etc.) is not connected when creating virtual ports in Router, the ports can overlap and will not work properly when you connect such device.

IMPORTANT: Before you begin to create virtual ports, attach all external devices you are using with computer and allow them to connect to the system. Restart Router and then create virtual ports.

Delete Port: Deletes any single virtual port.

Delete All: Deletes all previously created virtual ports.

Do not delete a virtual port until all applications using that port have been closed.

TIP: If you have removed another device which used virtual ports and Router does not offer the released port number, you will need to reset the virtual port bus. You can do this by deleting all virtual ports in Router at once. Select "Virtual Port | Delete All" then create the ports again. Any missing COM port numbers should appear.

NOTE: When Virtual Ports are first created, they are located in a special folder in the Device Manager called Virtual Serial Ports 7 (upper picture). After Windows restart, they are moved to common Ports (COM & LPT) folder.

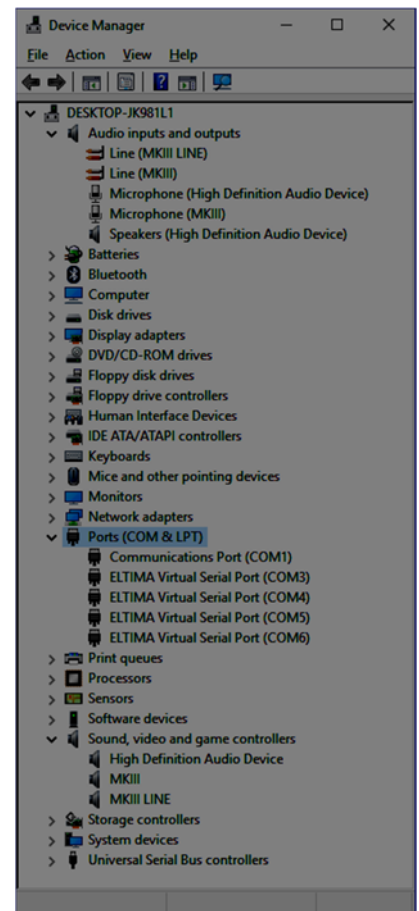

12 - DEVICE CONFIGURATION TABS

There are ten (10) tabs for configuring micro KEYER III. Each tab controls part of micro KEYER III's functions. Except for CW Messages and FSK Messages, any change is applied immediately.

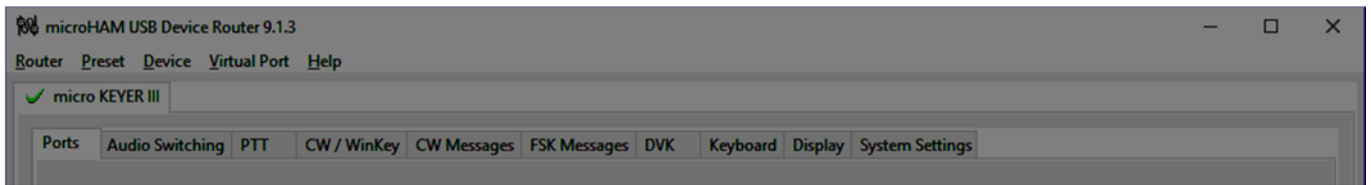

- 🔗 **Ports:** assign virtual ports to the micro KEYER III for use by applications
- 🔗 **Audio Switching:** configures microphone audio routing based on operator preference, application sound card handling and operating mode
- 🔗 **PTT:** configures T/R keying, keying sequencer and foot switch functions
- 🔗 **CW / WinKey:** configures the internal CW keyer
- 🔗 **CW Messages:** enter/store internal CW message memories
- 🔗 **FSK Messages:** enter/store internal FSK message memories
- 🔗 **DVK:** configure and control the level of Router's voice keyer
- 🔗 **Keyboard:** configure operation of PS/2 keyboard or keypad
- 🔗 **Display:** configures operation of the LCD display.
- 🔗 **System Settings:** configures power control and operation of the auxiliary CI-V/serial ports

PORTS TAB

Once the virtual ports have been created they must be associated with a specific function or device channel (e.g., Control, CW, PTT, etc.). These assignments should correspond to settings of the application software and must be configured first in Router then in the application.



Correct port assignment is critical for proper operation with application software.

micro KEYER III has 11 channels – each channel provides an indication of the settings applied by the application and current state (e.g., on or off):

- ⌘ **CAT** (uses RxD and TxD)
- ⌘ **2nd CAT** (virtual “fork” for the main CAT channel)
- ⌘ **FSK** (uses TxD for FSK and RTS for PTT if checked)
- ⌘ **2nd FSK** (uses TxD for FSK and RTS for PTT if checked)
- ⌘ **CW** (uses DTR or RTS)
- ⌘ **PTT** (uses DTR or RTS)
- ⌘ **2nd PTT** (uses DTR or RTS)
- ⌘ **Foot Switch** (uses CTS, DCD, DSR or RING)
- ⌘ **Auxiliary** (uses RxD and TxD)
- ⌘ **WinKey** (uses RxD and TxD)
- ⌘ **Control** (uses RxD and TxD)

NOTE: Do not assign virtual ports to the channels/functions which are not used by your applications. It is unnecessary and only consumes resources.

CAT Port

The CAT channel is used by the application software to control transceiver frequency, mode, T/R switching and many other parameters. The application communicates with the radio using a serial protocol. Although most modern radios implement some form of serial control, nearly every radio implementation is different. The degree of control available for each radio depends on that radio and the application (logger or digital program).

NOTE: The COM port number assigned in Router **MUST** match the port number assigned in the host application. First configure the virtual COM ports in Router then configure the application.

When a COM port is assigned in the Router but not in the application (or the application is not running) Router will indicate the channel is **closed**.



When an application opens the COM port assigned for control (usually at start-up), Router shows the channel as **open** and displays Baud rate, data bits, parity and number of stop bits used by the application. For example, 4800 8N2 means: 4800 Baud, 8 bits data length, parity = none, and two stop bits.

Data flowing through the CAT channel is indicated by two arrows. A green arrow indicates data flow from the host application to the radio and a red arrow indicates data flow from the radio to the application.

TIP: If the application provides for PTT (T/R) keying by radio control (CAT) turn this function OFF. PTT by CAT is not reliable because RFI can prevent the radio from switching back to receive. There is a dedicated T/R switching channel for this purpose called PTT.

NOTE: If your radio does not support handshake (most do not), configure DTR and RTS settings in your application program (logger) for Always On or Always Off. Do not select "Handshake."

For Router to determine the operating frequency and mode, it must know what radio (CAT protocol) being used. To select the radio, click the **Set** button, choose your radio in the **Radio** combo box, select communication speed in the **Baud rate** box, and set the CI-V address for Icom and some TenTec radios.

When the radio is communicating with Router, click Device | Store as Power-up Setting. This will save the radio type to the EEPROM and allow frequency decoding/iLink updates even if Router is not running (stand-alone mode).

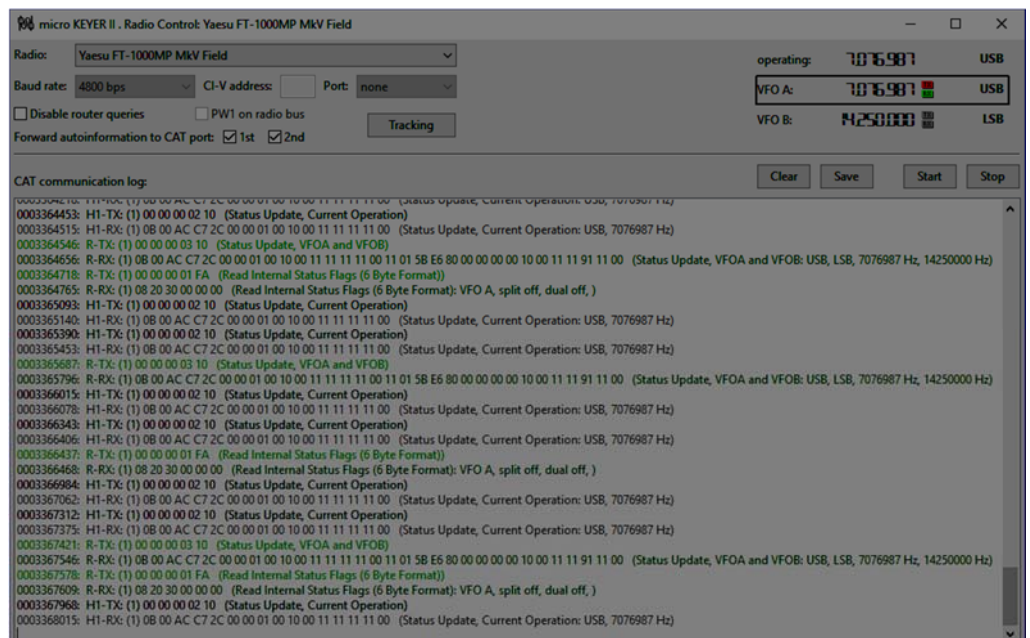

IMPORTANT: Disable **AUTOBAUD** in Icom transceivers. Set the radio, Router, and application software to operate at 9600 or 19200 Baud.

NOTE: The Baud rate must match your radio. Icom and some TenTec radios require the correct **CI-V address**. If everything is configured properly, your radio's current operating frequency and mode will be displayed.

Disable router queries – When this box checked, Router will not poll the radio for frequency and mode when that information is not available from the communication between the application and radio.

NOTE: "Disable router queries" disables Router polling only when the port has been opened by an application program. When the virtual port is closed, Router always polls the radio to support the automatic switching functions of micro KEYER III. If it is necessary to disable all polling, select one of the "none" options in the Radio box.

WARNING: DO NOT select "Disable Router queries" unless you have a specific reason to do so. Router only polls for information that is not requested by the logger and does not interfere with logger polling. Disabling Router queries may result in incorrect frequency and/or mode decoding and can have a serious impact on overall operation.

PW1 on radio bus – When this box checked, Router periodically generates an Icom "Transceive" broadcast to keep the PW1 synchronized.

NOTE: Check this box **only** if you have an IC-PW1 or other Icom compatible accessory physically connected (in parallel with the transceiver). Do not check this box if the only CAT connection is to the transceiver and the PW1 or other other accessory is connected to the accessory CI-V PA port (described later).

Forward autoinformation to CAT port: When checked, all unsolicited packets (Icom "CI-V Transceive" packets or "Auto-information" data from Kenwood, Elecraft and recent Yaesu transceivers), coming from the radio are transferred to the CAT port. Each CAT port has its own check box.

The bottom two-thirds of the **Radio** window is a CAT communication monitor. The monitor uses colors and tags to indicate which device is responsible for the data. Black queries (H1-TX or H2-TX) and gray radio responses (H1-RX or H2-TX) are from the "host" application (e.g., logger), H1 indicates the host application on the main CAT port, H2 is the host application on the 2nd CAT port. Green packets (R-TX and R-RX) are polls/responses from/to Router and not routed to the application.

Router monitors the communication when the host application performs control and polls the radio periodically for any missing information (VFO frequencies and mode). Because some applications do not poll the radio regularly or completely, Router must break this communication to update its internal state. In order to avoid confusing the application when Router polls the radio, data from the application is buffered and sent to the radio after Router receives a response to its query. If Router does not receive response to a poll within the time allowed or does not understand the response, it displays "oldest query discarded" but forwards all data to the virtual serial port to avoid confusing the application (logger).

USB transmits data in frames with a delay between frames, Router indicates frame boundaries with three dots (...). When a packet ends with three dots it means that the data continues in the next frame.

IMPORTANT: For micro KEYER III to operate properly when Router is not running, the settings must be saved as power-up defaults using "Device | Store as Power-Up Settings."

SDR Tracking

Since Router knows the frequency and mode of connected transceiver, it can provide this information for additional SDR receiver. Router can provide this information in two formats, Icom and Kenwood. Data in Icom format are optimized for connection to Perseus SDR. Data in Kenwood format are simulating TS2000 radio used by most SDR programs.

Radio: Specifies SDR receiver model. Current choices are Perseus and TS-2000 Compatible.

Port: Specifies COM port used to communicate with the SDR. For Perseus, COM port must be COM10 as number is fixed in Perseus control software. The port must be defined as a “virtual serial port for router interface”.

Source QRG: Specifies the frequency for the SDR to track. Where two sources are shown (e.g., VFO A, VFO B) the first source will be sent to the SDR in Receive and the second source in Transmit.

Offset: Frequency offset between the transceiver frequency and the frequency sent to the SDR. This is useful when the transceiver is used as an IF with a transverter. Default is 0Hz, resolution is 1Hz.

Track modes: Send mode as well as frequency to the SDR software.

NOTE: Tracking feature is working in one direction only, from Router to SDR. It means that SDR tracks band changes on transceiver but it isn't possible to change transceiver frequency from SDR.

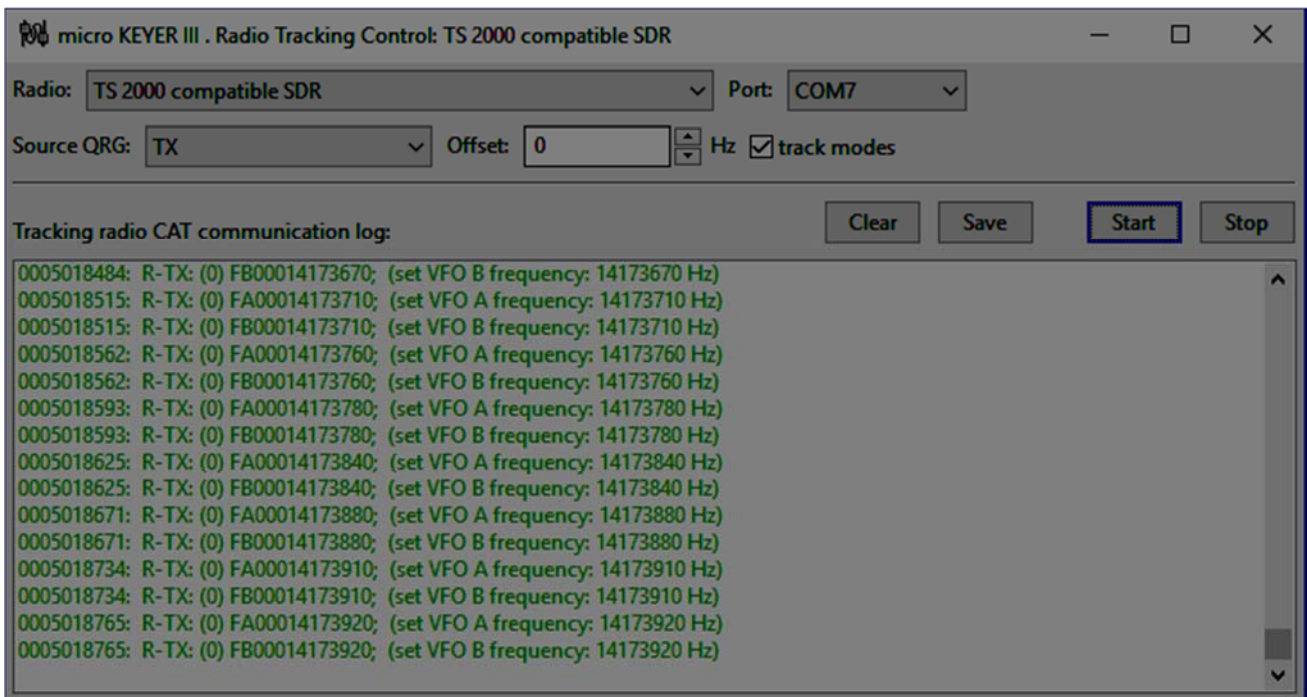

2nd CAT Port

Beginning with version 7.0, Router provides a unique control capability: the 2nd CAT Port is a managed data splitter/combiner (software 'Y' connector) that allows a second application to share control of the radio. Router monitors when data is sent from each application and routes the radio's responses to the correct virtual port.

IMPORTANT: Both applications must use same communication parameters (Baud rate, data length, parity and number of stop bits) for proper operation!

Neither CAT port has priority. Polls/commands from each application are processed alternately. In order to avoid collisions and avoid confusion due to unexpected data, responses from the radio are returned only to the application that generated the command. Unsolicited data from the radio such as automatic frequency/mode updates (Icom "transceive" packets or "Auto-information" data from Kenwood, Elecraft and recent Yaesu transceivers) can be forwarded to both CAT ports individually when appropriate "Forward autoinformation to CAT port" box is checked.

Due to limitations in the transceiver CAT port bandwidth and its processor load, there are several important rules which must be observed.

⌘ Total data throughput from both applications must not exceed maximum response rate of the transceiver. In other words, the polling rate from one application may need to be decreased to provide data space for the second application and vice versa.

⌘ Applications must be tolerant of response delays. Each logger must be able to wait for a response while the other logger communicates with the radio.

⌘ Due to protocol deficiencies in handling VFO split commands with many transceivers (particularly Icom), split mode must be initiated and ended by only one application and manual split control (from the front panel of the radio) should not be used.

NOTE: Although Router has been tested extensively using many different applications on the CAT and 2nd CAT ports, *microHAM* cannot guarantee proper operation with every possible combination of software.

FSK & 2nd FSK Ports

The FSK channels are used by application programs to send the FSK keying signal. FSK is used primarily for RTTY. It is very important to understand the difference between AFSK, FSK, P-FSK (OOK) and so called EXTFSK.

AFSK is an analog (audio) signal used to modulate the transceiver for digital modes like RTTY, PSK31, AMTOR etc. Computer sound card generated AFSK does not require special transceiver support and can be used in the LSB, USB or FM mode of the transceiver. Some radios have dedicated modes for AFSK (generally labeled PKT, DATA, LSB-D or USB-D) with special features; this is the preferred way to use, fully supported by MKIII audio switching.

FSK is a digital (On/Off) generated by UART shift register where timing of individual bits is based on crystal oscillator source and does not depend on computer load. FSK signal is used in the transceiver to generate a frequency shift. FSK operation must be supported by the transceiver, in general FSK mode is commonly labeled RTTY or FSK.

EXFSK is another method of On/Off FSK signal generation but switching between On and Off state is not generated by independent UART hardware or audio but directly by computer program. Exact length of individual bits depends on computer load what has negative impact on jitter. Jitter in RTTY signal means that individual bits have no constant length and decoding of jittery signal has higher error rate, even if signal is strong. In addition, jitter for EXTFSK is also influenced by principle of USB full speed isochronous transfer, where every On/Off state changes are sent not when actually happen but in 1ms granularity, and this sets a lower bound to the jitter, regardless of computer's CPU load. MKIII supports EXTFSK keying method but we do not recommend to use it if you can use FSK, P-FSK or AFSK instead.

P-FSK is next method of On/Off signal generation. It isn't generated by directly toggling signal on COM port as EXFSK, neither by UART but by sending special audio OOK (On Of Keying) signal, where audio is present for On state and not present for Off state. This method of On/Off signal generation is by quality comparable to UART based FSK if frequency of keying signal is high enough to not cause jitter and much superior to EXTFSK. MKIII supports P-FSK signal generation in right audio channel of USB Audio downstream.

IMPORTANT: If your transceiver supports FSK, use UART based FSK for RTTY whenever possible. MKIII provides perfect FSK output not achievable directly from computer or comparable to another FSK interfaces. It's the only sure way to get a clean RTTY signal no matter the microphone gain or compressor (processor) settings on your radio, spot on 45.45 Baud speed (resampled from 45 Baud), absolutely jitter free timing and with constant 1.5 stop bit.

When a COM port is assigned in Router but not in the application program (or the application is not running), Router will indicate the channel is **closed**.

When an application opens the COM port, Router will indicate the channel is **open** and display Baud rate, number of data bits, parity and number of stop bits in use. For example, 45 5N1.5 means: 45.45 Baud, 5 data bits, no parity, and 1.5 stop bits.

FSK:	COM4	<input checked="" type="checkbox"/> PTT	45 5N1.5	Test
2nd FSK:	none	<input checked="" type="checkbox"/> PTT		<input type="checkbox"/> invert <input checked="" type="checkbox"/> stuff
				<input type="checkbox"/> strict bps

The 2nd FSK port is useful when operating split with radios that have two receivers (e.g., FT-1000, 2000, 5000, 9000, K3, Orion or IC-7800/7851). The second instance of the RTTY program should specify "right channel" for its receive audio source and should be configured to use the 2nd FSK port for its FSK output.

Radios without a second receiver can use the 2nd FSK port for a second RTTY program with a different decoding algorithm to provide diversity decoding and permit transmitting from either program.

TIP: If you see a Baud rate other than 45 Baud (e.g., 4800 or 9600), the application is NOT configured correctly for FSK RTTY operation.

PTT: The virtual port used for FSK can also support PTT (required by MMTTY). When you use MMTTY, select the PTT box and RTS will be used for PTT. Do not use the FSK port for any other purpose.

Invert: Some transceivers lack the ability to set the sense of the FSK input. If you cannot set the proper sense, check the invert box. This is normally necessary only with the TenTec Omni V, Omni VI and Kenwood TS-940.

NOTE: Invert box in some RTTY programs **CANNOT** invert output of UART based FSK because such functionality is not available on computer hardware. It can invert only AFSK, hence you have to use Invert box in Router if signal invert function is not available in the transceiver menu.

Strict bps: Some programs rely on the the UART "byte sent" return signal for proper PTT timing and drop PTT (unkey) when the UART buffer is empty. Contrary to hardware UART in computer, USB based UART has two buffers - one in the USB driver and one in the USB hardware. The first buffer generally represented as Virtual COM Port is empty immediately because data are written to the memory, not physically shifted. Second buffer "byte sent" signal depends on implementation and buffer size for USB transfer and is usually as large as is necessary for single cycle transfer in already mentioned isochronous timing (1ms). Practically large enough for several hundreds of characters. Hence RTTY software using USB based UART port receives "byte sent" and "buffer empty" messages much much sooner than sent data are really shifted out to the transceiver. If program control PTT according to these events it drops PTT almost immediately. Some programs are aware of this problem and "computes" time when PTT should be released, like MMTTY with USB Option C. When RTTY programs lacks this feature, 'Strict bps' feature emulates "byte sent" and "buffer empty" events on virtual serial port according to real transfer speed. Unfortunately, timing is computed for 8bit character length not 5bit as is used for RTTY, therefore signaling is slower but proper PTT operation will be assured.

NOTE: DO NOT select Strict bps for MMTTY, USB option C provides pretty accurate PTT timing.

Stuff: Enables unique feature, not available on any other brand interface. This feature inserts diddle whenever PTT is on but FSK buffer in MKIII is empty for whatever reason, either by gaps in typing or by some delays in RTTY program or USB transfer. Inserting extra diddle at last point of FSK signal chain assures that individual characters has always constant 1.5bit stopbit followed by next character start bit, either valid one or another diddle. Keeping these stopbits in your TX stream is very important for receiving on the other side, as 1.5stopbits are only different bits than rest of data and are only reliable synchronization marks for receiver providing the fastest way to resynchronize decoder if receiving stream was interrupted by QSB, QRM, or other receive influences. We recommend you to keep this box checked.

To test FSK operation from the computer to the radio, click on **Test** button with no port assigned or the port closed. The Test button will generate "RY" two times.

CW Port

Router allows assigning a virtual serial port for software CW using DTR or RTS signals. The DTR* and RTS* are identical to DTR/RTS except that the output is inhibited until next state change after the COM port is opened. RTS*/DTR* should be used with programs that cause unwanted key-ups during startup.

When an application opens the COM port (usually at start-up), Router will indicate the channel is **open**. To test CW operation, click on the **Test** button with no port assigned or the port closed.

The state of the CW channel is indicated by a red arrow. If port is opened, it does not mean that it is properly configured. The red arrow will light in time with the transmitted CW when the port is properly configured.

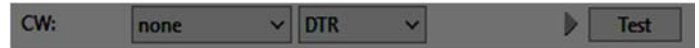

NOTE: If your logging program supports Winkey, used it instead direct DTR/RTS CW generation, performance is much superior.

PTT & 2nd PTT Ports

The PTT channels are used to control transmit/receive switching of the transceiver and power amplifier. An internal sequencer assures 100% protection against hot switching of the PA when the PTT channel is used. More information about T/R switching and the sequencer is provided under the PTT tab.

Router allows assigning virtual serial ports for PTT using the DTR or RTS signals. DTR* and RTS* are same as DTR*/RTS* for CW inhibited until next change after the COM port is opened and should be used with programs that cause unwanted key-ups during startup.

The state of the PTT channel is indicated by a green arrow. If the port is opened, it does not mean it is properly configured. When the port is properly configured, the arrow will light during the entire transmission.



The 2nd PTT channel is identical to the primary PTT channel. 2nd PTT provides a way for a second application to key the radio if the primary application also controls PTT – for example, a logging program and CW reader/keyboard.

To test PTT, click on the **Test** button with no port assigned or the port closed.

Foot Switch

Router allows assigning a virtual serial port to the foot switch channel and selecting one of four available input control lines (CTS, DCD, DSR or RING).

NOTE: CTS is not available if the foot switch channel is shared with the radio control port. The state of the signal on the virtual port can be inverted by checking **inverted** box.

When a COM port is assigned for the foot switch but the application does not support foot switch status (or no application is running), Router reports the channel as **closed**.

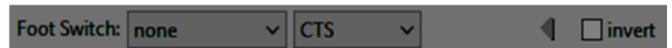

When an application opens the COM port (usually at start-up), Router reports channel as **open**.

When the foot switch is pressed, this state is indicated by a red arrow.

WinKey Port

WinKey is a unique external CW processor developed by Steve Elliot, K1EL. MKIII uses version WKv3.

This CW processor supports paddle input like any other electronic keyer, offers many configuration options, and in addition converts ASCII data from the computer to Morse characters. This unique property assures perfectly timed CW output from the computer regardless of OS load. More detailed instruction for configuring WinKey is found in the description of the CW/WinKey tab.

When a COM port is assigned to WinKey in Router but not in the application program (or no application is running), Router reports the port **closed**. When an application opens WinKey, (usually at start-up), Router shows the port **open** and displays settings used to configure COM port.

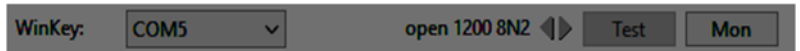

NOTE: If you see settings other than 1200 8N2, the application is not configured correctly for WinKey. If the data rate is incorrect, Router will transfer data to WinKey at 1200 Baud. However, reliable operation is not guaranteed.

Data flow is indicated by two arrows. The green arrow indicates data flow from the application to WinKey and the red arrow indicates data flow from WinKey to the host application.

Test: Sends "Test" via WinKey when the channel unassigned or closed.

Mon: "WinKey Monitor" allows capturing communications between Router or the application and WinKey. Controls for the monitor include **Start**, **Stop**, **Clear** and **Save**.

WinKey Monitor should not be used under normal conditions. However, if there are problems with WinKey and a logger, it may be useful to **Start** a capture and close the window. When a problem is noticed, the window can be opened and the WK communications log **Saved** for analysis.

WinKey Monitor is circular – only the last 20 kilobytes or so will be saved in order to prevent creating very large files.

WK Monitor will display a description of each command from Router or the application and "decoded" response from WinKey. " If a line ends in three dots (...) it means that the command or response has been broken across two USB packets.

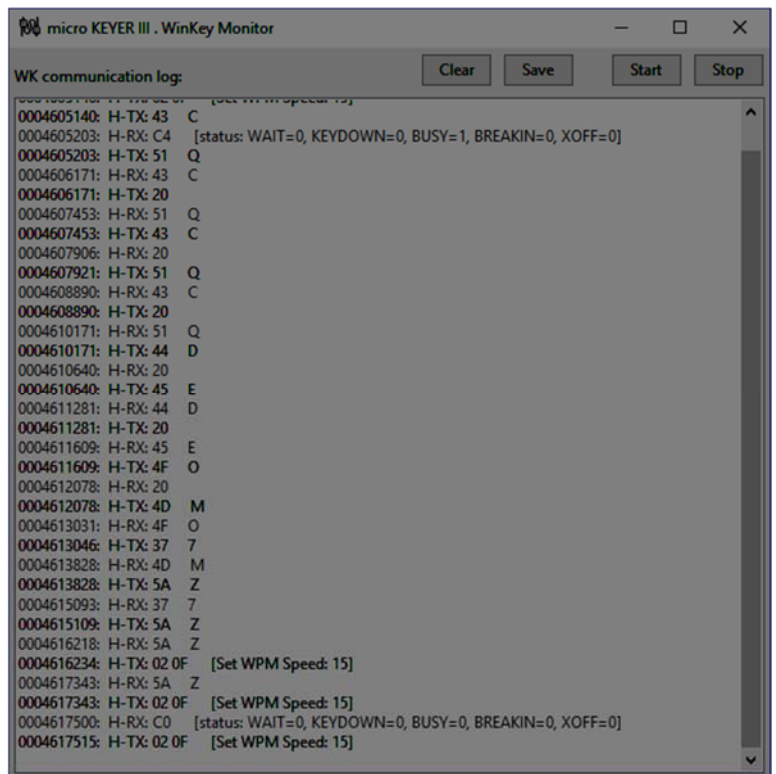

NOTE: Numbers in brackets on H-TX: data means forced value sent to Winkey contrary to request from logger in order to match settings on CW / Winkey tab and hardware implementation in of WK chip in MKIII. This feature can be partially disabled at CW / Winkey tab.

Auxiliary Port

The Auxiliary Port allows an application program (logger) to control an auxiliary device attached to the iLink port. The Auxiliary port implements serial in and serial out (RxD and TxD) as TTL signals – interfacing to an RS-232 device will require a TTL to RS-232 converter, for example the *microHAM* iLINK – UltraBeam or iLINK – SteppIR adapter.

When an application opens the Auxiliary port, Router reports port as **open** and displays settings used to configure COM port.



Data flowing through the channel are indicated by two arrows. The green arrow indicates data flow from the application and a red arrow indicates data to the host application.

Mon: Opens an “Auxiliary Serial Port Monitor” window to capture data between the application and auxiliary device. Controls for the monitor include **Start, Stop, Clear** and **Save**.

The Auxiliary Serial Port Monitor should not be used under normal conditions. However, for debugging purposes, it may be useful to **Start** a capture and close the window. When a problem occurs, the window can be opened and the Serial Port log **Saved** for analysis.

The monitor log is circular – only the last 20 kilobytes or so will be saved in order to prevent creating very large files. If a line ends in three dots (...) it means that the command or response has been broken across two USB packets.

Control Port

The Control Port allows an application program (logger) that implements the **microHAM Control Protocol** to make use of the micro KEYER III CW, FSK and DVK message memories as well as other features.

When an application opens the control port, Router reports port as **open** and displays settings used to configure COM port.



Data flowing through the channel are indicated by two arrows. The green arrow indicates data flow from the application and a red arrow indicates data to the host application.

Mon: Opens a “Control Protocol Monitor” window to capture microHAM Protocol communications between a logger and Router. Controls for the monitor include **Start, Stop, Clear** and **Save**.

The Control Protocol Monitor should not be used under normal conditions. However, if there are problems between a logger and Router, it may be useful to **Start** a capture and close the window. When a problem is noticed, the window can be opened and the Control protocol log **Saved** for analysis.

The monitor log is circular – only the last 20 kilobytes or so will be saved in order to prevent creating very large files. The monitor will display a description of each command from the application and the response from Router. If a line ends in three dots (...) it means that the command or response has been broken across two USB packets.

AUDIO SWITCHING TAB

micro KEYER III uses an advanced, custom USB audio subsystem which allows Router to handle all of the audio routing. Audio Switching tab defines how and where all audio signals will be connected to according to operating mode and operating preferences. During explanation we will finish hardware settings of MKIII too.

On transmit, the selected microphone or sound card output will automatically be connected to the transmitter's microphone or line (rear panel) input based on the mode, and optionally frequency, reported by the transceiver in response to polling by the application (logger) and/or Router. If Router is not able to read the operating mode from your radio (radio does not have computer control port or does not report usable mode information), you can select one of four fixed "no radio" modes or one "no radio" mode with manual (keyboard/keypad) mode selection.

Some radios fail to provide a separate mode for digital operation or the serial control protocol implemented by the radio does not report the digital mode when operating AFSK, PSK or other audio based digital modes. This is true for all Kenwood transceivers, most Ten-Tec transceivers, most older Icom transceivers and the Elecraft K2. With those radios, digital operation (except for FSK) must be done using voice modes (USB or LSB).

The traditional method – feed the microphone jack from the sound card output through a transformer – is not optimal for many reasons: you need to remember to turn off any speech compressor and EDSP or other signal processing when using audio modulation for digital modes. In addition, the microphone amplifier in the radio can cause distortion because it is optimized for voice and its frequency response is often not as flat as necessary for digital modulating signals.

The proper method is to feed sound card audio to the microphone jack only for voice modes (SSB, AM, FM), and feed it to the jack designed for digital modes – generally on the transceiver's rear panel – when using sound card based digital modes. Even though the radio may not report a unique DIGITAL mode, Router can

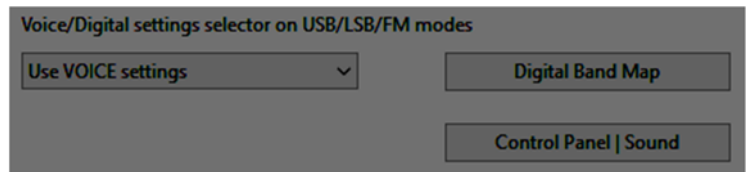

make an intelligent choice and apply the DIGITAL or VOICE configuration for Audio and PTT based on the operating frequency from the radio. The **VOICE/DIGITAL settings selector** is used to control automatic switching when the operating frequency is in the "Digital Band" as defined in the **Digital Band Map** and the transceiver is in USB, LSB or FM mode.

Select by frequency: Router will select DIGITAL settings when detecting a frequency inside the "Digital Mode" boundaries. These boundaries can be fully customized in the Band Map by clicking the Digital Band Map button or selecting Router | Options | Digital Band Map. Outside of these frequency boundaries, VOICE settings will be used .

NOTE: Use "Select by frequency" only if your radio does not have a dedicated mode (PKT, DIG, DATA, or USB-D/LSB-D etc.) for audio based digital modes like FT8, PSK31, MFSK, AFSK-RTTY etc. and you must use USB/LSB/FM for digital operation.

Use VOICE settings: VOICE settings will be used for USB/LSB or FM modes regardless of frequency. This should be used with most Yaesu transceivers, late model Icom transceivers that support USB-D and LSB-D and the Elecraft K3. Router will select "DIGITAL" when it detects the special digital modes like PKT, DIG, DATA, FSK, RTTY, USB-D, LSB-D and use the "VOICE" settings for USB/LSB and FM.

Use DIGITAL settings: DIGITAL settings will be used regardless of frequency for USB/LSB or FM.

Control Panel | Sounds: Provides shortcut to open Windows Control Panel | Sounds.

The **VOICE** and **FSK/DIGITAL** settings can independently specify whether audio generated by **MKIII Line** sound card output should be sent to the microphone jack or line input of the connected radio based on the operating mode.

NOTE: Arrows in routing picture are “live” and change according to selected audio routing. Grey arrow indicates active audio path but without signal, red arrow indicates active audio path with audio transfer.

VOICE settings:

Microphone jack, DVK control:

The audio output from MKIII Line is connected to the transceiver's microphone jack when transmitting in VOICE mode, microphone is under DVK control. "On Air recording" checkbox on DVK tab controls if DVK recording will be On or Off Air. This is recommended choice for VOICE operation (SSB/AM/FM).

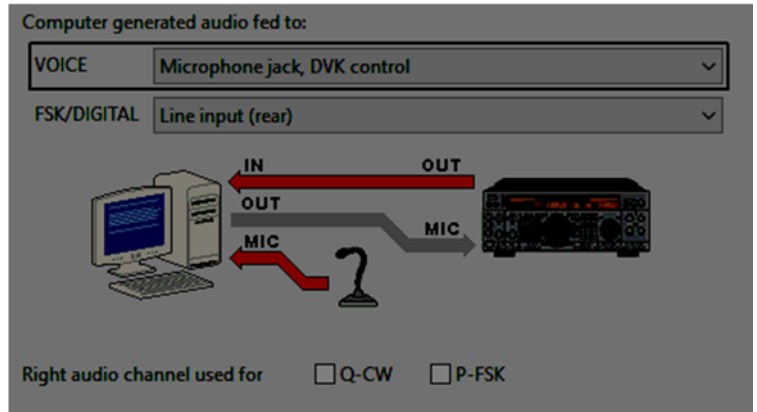

Microphone jack, logger control:

The audio output from MKIII Line is connected to the transceiver's microphone jack when transmitting in VOICE mode, microphone is under logger control. Logger controls On or Off Air DVK recording by MUTE box on Playback Microphone channel of MKIII Line output. This is recommended choice for VOICE operation if you are not using contest logger support for our DVK but prefer logger's internal DVK.

Line input (rear): The audio output from MKIII Line is connected to the transceiver's rear panel line (ACC) input. This is very special audio routing option you should use when you have external processing unit (External DSP) plugged between line output of MKIII and line input of the transceiver.

Remote microphone: The audio output from MKIII Line is connected to radio microphone jack all the time and microphone input of the radio does not switch to the local microphone. This selection is useful for use with computer based transmit audio DSP processing (for example, 3rd party audio equalizer software) or for use with remote operation of MKIII.

FSK/DIGITAL settings:

Line input (rear): Audio output from MKIII Line is connected to the radio rear panel line (ACC) input all the time. This is the default setting for FSK/DIGITAL operation.

Microphone jack: Audio output from MKIII Line is connected to the radio microphone jack all the time when you are operating in FSK/DIGITAL mode. This setting is useful for SSTV where you need instant switching between computer and microphone without changing mode on radio, or for radios like FT-1000MP which doesn't support USB digital modes required by some digital modes like FT8. Should be used together with VOICE/DIGITAL selector set to Use DIGITAL settings and set as separate settings Preset (described later) named SSTV or FT8 or similar. This way MKIII will not switch audio output between microphone jack and line input, but will keep separate output levels for VOICE and DIGITAL.

NOTE: The graphic is “live” and shows the current audio routing. The grey lines show the selected audio path and the red lines show those paths currently transferring audio. The graphic is an excellent tool for troubleshooting the audio configuration.

P-FSK: Right channel audio output from MKIII Line sound card will be used as keying signal for FSK.

Q-CW: Right channel audio output from MKIII Line sound card will be used as keying signal for CW.

Microphone Selection

micro KEYER III supports two microphone inputs MAIN MIC and EXT MIC, both are located on rear panel. The MAIN, RJ-45 input supports the stock OEM transceiver microphone, including support for any special microphone "button" controls.

If the transceiver microphone uses circular Foster 8 connector, use the supplied RJ-45 – Foster 8 adapter. If the transceiver microphone uses RJ-45 connector, you can plug it directly to MAIN MIC jack.

IMPORTANT: Yaesu MD-100/200 microphones contain reversible coiled microphone cord. Do not reverse cord in order to skip RJ-45 – Foster 8 adapter for radios with circular Foster 8 connector. By reversing spiral cord you change pinout of microphone and it will not work. Another important detail on MD-100 microphone is PTT switch on microphone body (not stand). Make sure this PTT button is NOT inadvertently depressed.

The 3.5 mm EXT MIC jack can be configured to support electret or dynamic headset or boom microphones.

EXT: Always use rear panel (3.5 mm) **EXT MIC** input.

MAIN: Always use rear panel (RJ-45) **MAIN MIC** mic input.

Auto: Selects microphone automatically.

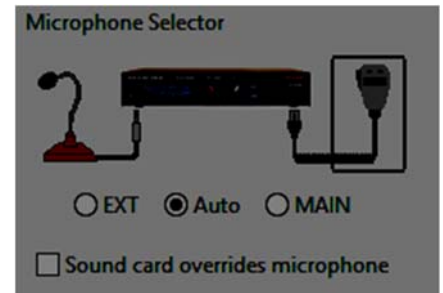

When enabled, MKIII features automatic microphone selection. If both microphones are plugged in, EXT MIC has priority. However, when you press PTT button on MAIN MIC microphone, MAIN MIC overrides EXT MIC priority. Using footswitch for PTT, EXT MIC priority is not overridden.

The black box will show the selected microphone in real time as well as audio routing status on OLED display. **MM** stands for MAIN MIC, **EM** stands for EXT MIC.

Sound card overrides microphone: When checked, audio from the sound card can override signal from microphone even if footswitch is depressed. If "Restore serial PTT and audio routing" is checked on the PTT tab, sound card audio will be restored on footswitch release. If is NOT checked, transceiver returns to RX state on footswitch release and computer audio will not be restored until next sound card sending cycle.

NOTE: The black box here and on other tabs in Router is "live." It indicates which settings are currently in use. When the black box turns gray, it indicates that Router lost connection with the radio or has expired information (CAT port problem). While the boxes are gray, the settings may not be correct.

Transmit Monitor

micro KEYER III includes a monitor amplifier that provides 1 watt to a user supplied speaker.

IMPORTANT: Connect speaker to MONI jack using stereo plug, with speaker connected between TIP and RING. Sleeve is not used.

Router will select the audio source to be monitored based on the operating mode. The monitor level can be set independently for each mode. In CW, the sidetone frequency is selectable from 338, 450, 675 and 1350 Hz. Sidetone can be enabled for all CW output or only manual (paddle) input. In voice mode, DVK output is selected and in Digital mode the sound card output is selected.

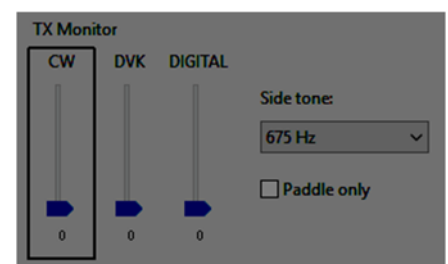

NOTE: TX Monitor contains ONLY transmit audio and CW sidetone generated by MKIII. It does not include receive audio from the transceiver.

HARDWARE INSTALLATION ... part III

Computer Audio Levels Setup

MKIII is intentionally designed to have all level controls at one place and it is MKIII. Although level sliders are present for audio devices on computer, they are ignored and do nothing. Only reason for their presence on computer is to keep USB Audio Class implementation requirements to not cause incompatible situations. Concentrating level adjustment in MKIII greatly simplifies setup process because input/output level adjustment on computer is no longer needed to be considered.

Now it is a right time to finish HW settings of MKIII we couldn't do before audio switching explanation and working CAT control. Go to SETUP menu 2.2 and set TX gain to **0dB** by adjusting TX knob on MKIII front panel. Connect dummy load or go to dead band to not cause QRM.

VOICE mode driving level:

- 🔗 Set radio to USB mode. Make sure the radio is configured to use MIC input for VOICE modes and not line. Icoms have it set by default for both, you need to change DATA OFF MOD = MIC. Please refer to transceiver manual for details.
- 🔗 Go to Audio Switching tab in the Router and set VOICE/DIGITAL switching to **Use VOICE settings**. On macOS/Linux set **ACA** or **CCC** switching for VOICE mode.
- 🔗 Make sure the black rectangle is around the VOICE settings and set them to **Microphone jack, DVK control**. Verify you can see **VOICE/MIC** shown on OLED display.
- 🔗 If you are using compressor, turn it on.
- 🔗 Push the knob to generate test TONE and verify the OLED display shows TT->M audio routing in status area. Adjust level by RX MAIN knob to see proper ALC, and COMPRESSOR level on radio. When done, Push knob to turn off the test tone, computer audio output level for VOICE mode is set.

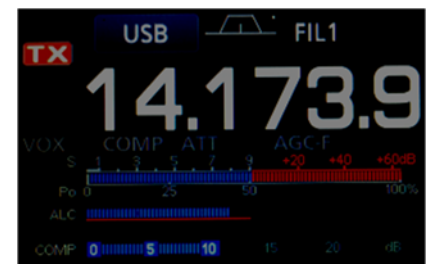

DIGITAL modes driving level for line input:

- 🔗 Set radio to digital mode (USB-D, PKT, DIG etc ...), but no RTTY or FSK, or CW. Make sure the radio is configured to use line (ACC) input for digital modes, not MIC. Again, Icoms need to be set to DATA MOD = ACC. Please refer to your transceiver manual for details.
- 🔗 If your transceiver doesn't have digital modes, set VOICE/DIGITAL selector to **Use DIGITAL settings**. On macOS/Linux set **BBB** switching for DIGITAL mode.
- 🔗 Make sure the black rectangle is around the DIGITAL settings and set them to **Line input (rear)**. Verify you can see **DIGI/LINE** shown on OLED display.
- 🔗 Push the knob to generate test TONE and verify the OLED display shows TT->L audio routing in status area. Adjust level by RX MAIN knob to see no ALC, and no COMPRESSOR level on radio. Do not move TX knob, it has to be at 0dB. When done, push knob to turn off the test tone, computer audio output level for DIGITAL mode to line input is set.



DIGITAL modes driving level for microphone input:

- 🔗 Set radio back to USB mode.
- 🔗 Go to Audio Switching tab in the Router and set VOICE/DIGITAL switching to **Use DIGITAL settings**. On macOS/Linux set **CCC** switching for DIGITAL mode.
- 🔗 Make sure the black rectangle is around the DIGITAL settings and set them to **Microphone jack**. Verify you can see **DIGI/MIC** shown on OLED display.
- 🔗 Push the knob to generate test TONE and verify the OLED display shows TT->M audio routing in status area. Adjust level by RX MAIN knob to see no ALC, and no COMPRESSOR level on radio. Keep TX knob at 0dB. When done, push knob to turn off the test tone. Computer audio output level for DIGITAL mode to microphone input is set.



At this point you have all levels set and you can run any digital mode or SSB with confidence that the driving levels are set correctly.

PTT TAB

The PTT tab allows configuring PTT operation and sequencing.

PTT INPUTS:

micro KEYER III has six PTT sources:

- 🔗 Serial PTT generated by the logging program on the virtual COM port RTS or DTR.
- 🔗 2nd PTT generated by an another application on the virtual COM port RTS or DTR.
- PTT and 2nd PTT behave the same and generate the same **Serial PTT** input.
- 🔗 A foot switch attached to the rear panel RCA jack.
- 🔗 The PTT switch of the microphone connected to the MAIN RJ-45 MIC jack.
- 🔗 WinKey generated PTT.
- 🔗 The sound card active audio generated "Sound card PTT."
- 🔗 Special PTTIN input to sense radio TX state if switched to TX by CAT, VOX or MOX.

PTT OUTPUTS:

micro KEYER III has four PTT outputs: PTT1, PTT2, PA PTT and LNA PTT. PTT1 and PTT2 are brought out to the DB37 Radio connector. PA PTT and LNA PTT are RCA jacks for connecting to external devices.

PTT1 is wired to the radio microphone jack and is generally used for CW and VOICE modes.

PTT2 is wired to the radio Accessory jack and is used to switch the radio into transmit in DIGITAL and FSK modes.

NOTE: PTT2 or "rear panel" PTT is used by some radios to mute the microphone and disable speech processing circuits (clippers, audio equalizers, transmit DSP, etc.) that can distort digital modulation.

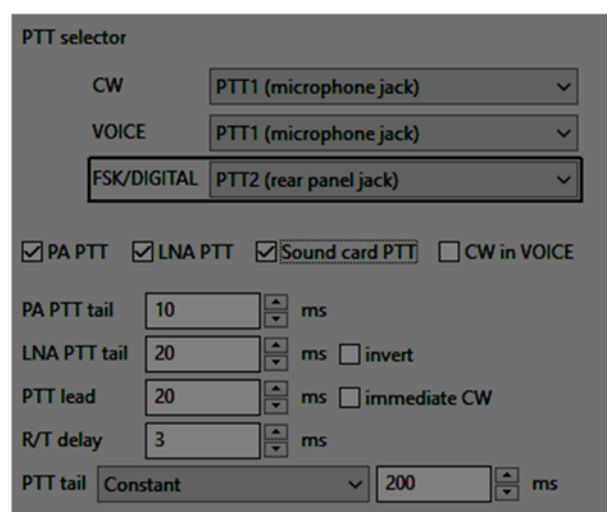

PA PTT is on the micro KEYER III rear panel. It is designed for controlling an amplifier. PA PTT will close before PTT1 and PTT2 by the amount of **PTT lead** and open after the transceiver PTT by **PA PTT tail** setting. In CW mode PTT1, PTT2, PA PTT and LNA PTT will close simultaneously, actual RF generation

by CW signal is delayed by PTT Lead.

NOTE: PA PTT tail should be set to provide a few milliseconds of delay after the transceiver PTT releases. Some transceivers produce RF even after their "amplifier PTT" drops and the delay will prevent "hot switching on release".

LNA PTT is on the micro KEYER III rear panel. It is designed for bypassing a low noise preamplifier (LNA) or disabling receive antennas during transmit. LNA PTT is enabled by checking the **LNA PTT** box. LNA PTT will close before PTT1 and PTT2 by the amount of **PTT lead** and open after the transceiver PTT by **LNA PTT** tail setting. Again, in CW mode PTT1, PTT2, PA PTT and LNA PTT will close simultaneously, actual RF generation by CW signal is delayed by PTT Lead. Output polarity, normally open can be changed to normally closed by checking **Invert** box.

micro KEYER III can select PTT1 or PTT2 based on the mode reported by the transceiver. Router groups operating modes into three classes: CW, VOICE (USB, LSB, AM and FM) and FSK/DIGITAL.

PTT IN is special input on MKIII. It doesn't serve as regular PTT input but as a sense if radio was switched to TX state by some other way than through MKIII, like VOX, CAT PTT command or manually on the transceiver. When MKIII sees PTT IN closed, it starts sequencer but does not close any PTT1 or PTT2 output even if they are defined for selected operating mode to not cause dead lock what would stuck radio in TX. PA and LNA PTT are generated.

The available PTT options are:

CW:

- ☞ PTT1 (microphone jack)
 - ☞ Signal is bought to microphone jack by DB37 cable microphone lead.
- ☞ QSK
 - ☞ PTT to radio is not generated, PA PTT and LNA PTT include only PA/LNA PTT Tail.
- ☞ Semi Break-in
 - ☞ PTT to radio is not generated, PA/LNA PTT include PTT Tail and PA/LNA PTT Tail.
- ☞ PTT2 (rear panel jack)
 - ☞ Signal is bought to radio accessory input by DB37 cable.

VOICE:

- ☞ PTT1 (microphone jack)
- ☞ PTT2 (rear panel jack)

FSK/DIGITAL:

- ☞ PTT1 (microphone jack)
- ☞ PTT2 (rear panel jack)
- ☞ PTT1 & PTT2 (both jacks)

PA PTT: Enables PA PTT

LNA PTT: Enables LNA PTT

Sound card PTT: Enables automatic PTT when the sound card is producing audio.

CW in VOICE: Enables CW output in Voice modes. Please note, this function must be supported by the transceiver. CW in Voice always operates without transceiver PTT (Semi Break-in).

PTT lead: Specifies lead-in delay.

In CW with PTT1 or PTT2, PTT lead is the time between the closure of PA PTT/LNA PTT and the activation of PTT1/ PTT2/CW Output.

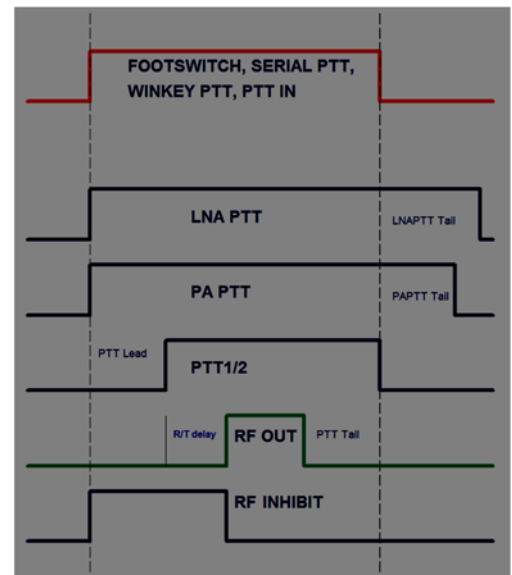

In CW with Semi Break-in, PTT lead is the time between the closure of PA PTT/LNA PTT and the start of CW Output.

In CW with QSK, PTT lead is the time between the time the paddle is closed and CW output. The leading edge of PA PTT and LNA PTT are coincident with the CW output.

In VOICE and FSK/DIGITAL, PTT lead is the time between closure of PA PTT/LNA PTT and activation of transceiver PTT (PTT1 or PTT2).

If **immediate CW** box is checked, CW is generated immediately. This settings is violating sequencer protection and should be used only if you for some reason need very long PTT Lead prevent you to use paddle for CW. Start of CW sending is under your control, use with care!

PTT tail: Defines how long PTT1 or PTT2 remains closed after the last CW character. PTT tail can be set to a constant value or can be proportional to the CW speed between seven (1.00 wordspace) and ten (2.00 wordspace) dot lengths.

R/T delay: Defines the transceiver switching time from receive to transmit if PTT signal is issued at the beginning of the switching sequence. R/T time adds to PTT Lead time. Applies for all modes but in QSK operation, R/T delay is used as Keying Compensation parameter for Winkey to extend every CW element for defined length. In Semi Break-In operation R/T delay is used as suppressed PTT Lead parameter for Winkey (PTT not generated but PTT Lead considered) to assure that keying sequence is started correctly.

PA PTT tail: Defines the time that PA PTT remains closed after transceiver PTT (PTT1 or PTT2) and/or PTT IN opens when switching from transmit to receive.

LNA PTT tail: Defines the time that LNA PTT remains closed after transceiver PTT (PTT1 or PTT2) and/or PTT IN opens when switching from transmit to receive.

NOTE: LNA PTT tail should always be greater than or equal to PA PTT tail.

Footswitch Sequencer

With the footswitch (or MAIN MIC PTT button), additional functions can be associated. micro KEYER III recognizes when the footswitch is closed (depressed) or open (released) and can manipulate CW, FSK, PTT and audio routing accordingly.

Mute serial CW - if checked, serial CW signal over DTR or RTS from a logger will be muted while the footswitch is pressed. If **Restore serial CW** is checked, CW will resume when the footswitch is released (if it has not already ended). If **Restore serial CW** is not checked, logger generated CW will remain suppressed until the logger releases PTT.

Mute serial FSK - if checked, the FSK output will be blocked while the footswitch is pressed. If **Restore serial FSK** is checked, FSK will resume when the footswitch is released (if it has not already completed). If **Restore serial FSK** is not checked, FSK will remain suppressed until the logger releases PTT.

Restore serial PTT and audio - if checked, logger generated serial PTT will be restored and audio routing will return to the "serial PTT" setting when the footswitch is released. If **Restore serial PTT and audio** is not checked, audio will only return after the logger releases PTT.

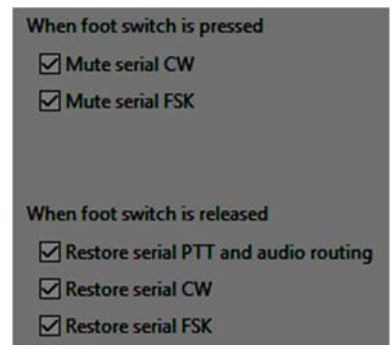

CW / WINKEY TAB

This tab provides the configuration for the WinKey based, internal CW keyer. MKIII uses genuine Winkey chip version 3 developed by Steve Elliott, K1EL. A complete WinKey manual can be downloaded from: https://www.hamcrafters2.com/files/WK3_Datasheet_v1.pdf

WinKey can be controlled by a logging program or operate in stand alone mode controlled by Router. Router controls the speed range, Paddle mode and other timing characteristics of WinKey. When an application (logger) opens WinKey, Router plays no part in buffer handling and speed control. All other settings remain under Router control, application settings are discarded to avoid hardware setup misconfiguration, timing issues and to keep WinKey behavior consistent across applications.

NOTE: WinKey parameters are stored separately for each Preset. This allows quick selection of parameters by choosing different preset. The Paddle swap parameter can be also controlled from attached PS/2 keypad.

WARNING: Do not change parameters while an application (logger) is actively accessing WinKey.

When WinKey is closed, the basic operating parameters can be adjusted on this tab. Every change is applied immediately.

Paddle Mode

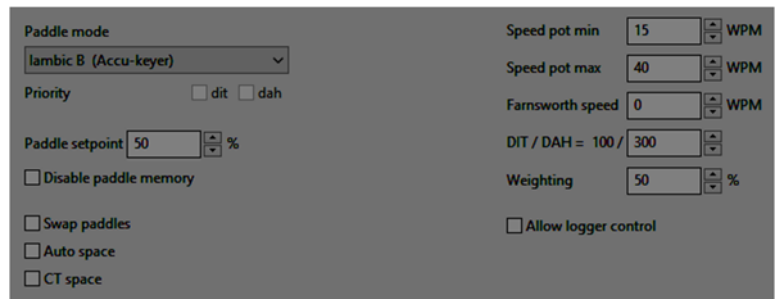

- ⌘ la
Iambic A (Curtis)
- ⌘ la
Iambic B (Accu-keyer)
- ⌘ UI
Ultimatic (Single lever)
- ⌘ B
Bug Keyer (Vibroplex emulation)

NOTE: To connect a straight key to MKIII, use "Bug Keyer" mode. The straight key should be connected between ring and sleeve of a three conductor plug. The tip must be open.

Priority: Ultimatic mode offers a choice if DIT or DAH priority for dual lever paddles. If no priority is selected, the keyer works in a "last paddle wins" mode.

Paddle set point: Controls when WinKey begins looking for a new paddle press after sensing the current one. The default value is one dit time (50) and is adjustable in percent of a dit time.

Disable paddle memory: When checked, DIT (or DAH) insertion is disabled.

Swap paddles: Reverse paddle sense for left handed operation or improperly wired paddle.

Auto space: Keyer generates automatic character space.

CT space: Selects "contest" word space (six elements long instead of seven).

Speed pot min/max: Min/Max value of the front panel speed knob (9) in range 5 to 99 WPM.

Farnsworth speed: Sets the Farnsworth keying speed (10 to 99 WPM range, 0 disables this feature).

DIT / DAH: DIT/DAH ratio from 1:2 to 1:4 in hundreds. Accepted numbers are from 200 to 400.

Weighting: Weighting in percentage (from 10 to 90%).

Allow logger control: Special setting for diagnostics. When checked, Router no longer keeps WK parameters synchronized and does not overwrite configuration sent from logger except items related to the hardware setup of the Winkey chip. **Do not use** unless instructed to do so by the factory.

CW MESSAGES TAB

On this tab you can define nine CW messages of up to 50 characters each which are stored in EEPROM. Each memory may have a programmable repeat delay and/or call another memory.

Message content	Jump to	Delay [s]	Test on CW	
1 CQ CQ DE OM7ZZ OM7ZZ K	-	0	Test	Store
2 DE OM7ZZ	-	0	Test	Store
3 OM7ZZ	-	0	Test	Store
4 5NN	-	0	Test	Store
5 55N	-	0	Test	Store
6 CFM	-	0	Test	Store
7 TU	-	0	Test	Store
8	-	0	Test	Store
9 CQ DX CQ DX DE OM7ZZ OM7ZZ DX K	-	0	Test	Store

Content of message 9. To insert special commands use buttons below.

Merge Cancel WPM

Par. 5 Set WPM 05 Set Key 05 Set Wait 05 Store All

Commands which may be included in a memory are:

- Merge:** Merge two characters without a letter space – [M]AS will sound AS .-...
- Cancel WPM:** Restore speed set by the Speed pot.
- Set WPM:** Force speed to the selected value regardless of position of speed knob.
- Set Key:** Close CW output for selected time in seconds.
- Set Wait:** Wait selected seconds during playback.

- Jump to:** Used for looping a message or calling another message
- Delay:** Sets the delay in seconds before looping or calling another message

- Test:** Plays a message without storing it
- Store:** Saves one message to micro KEYER III memory
- Store All:** Saves all messages to micro KEYER III memory

- Load from File:** Loads all messages from file
- Save to File:** Saves all messages to file

Messages can also be saved and replayed using an external keyboard or numeric keypad attached to the **PS/2** jack. See: KEYBOARD TAB chapter

NOTE: Messages are not saved or loaded with Presets

FSK MESSAGES TAB

On this tab you can define nine FSK messages of up to 50 characters each which are stored in EEPROM. Each memory may have a programmable repeat delay and/or call another memory.

Message	Message content	Jump to	Delay [s]	
1	[CR][LS]RYRY CQ CQ DE OM7ZZ OM7ZZ K	-	0	Store
2	[CR][LS]DE OM7ZZ OM7ZZ	-	0	Store
3	[CR][FS]599 599 K	-	0	Store
4	[CR]OP JOZEF JOZEF	-	0	Store
5	[CR][LS]TNX FOR QSO, 73 OM7ZZ	-	0	Store
6		-	0	Store
7		-	0	Store
8		-	0	Store
9		-	0	Store

CR & LF
Figure
Letter
Blank
BEL

Store All

Commands which may be included in a memory are:

- CR & LF:** Insert Carriage Return/Line Feed
- Figure:** Insert special Figure character
- Letter:** Insert special Letter character
- Blank:** Insert special Blank character
- Letter:** Insert special Bell character

- Jump to:** Used for looping a message or calling another message
- Delay:** Sets the delay in seconds before looping or calling another message

- Store:** Saves one message to micro KEYER III memory
- Store All:** Saves all messages to micro KEYER III memory

- Load from File:** Loads all messages from file
- Save to File:** Saves all messages to file

Messages can also be saved and replayed using an external keyboard attached to the **PS/2** jack. See: KEYBOARD TAB chapter

NOTE: Messages are not saved or loaded with Presets

DVK TAB

micro KEYER III allows recording and playing an unlimited number of messages (limited only by the capacity of the computer hard drive) - nine voice messages per bank. Banks can be managed with Rename, Add and Remove buttons. **Rename** to rename the current bank, **Add** to create a new bank, and **Remove** to delete the current bank. Bank selection is provided by **Bank** box.

Each memory may repeat with a programmable delay (loop) or can be chained with another memory using external keyboard or keypad.

While a DVK message is being recorded or played micro KEYER III uses the DVK mixer settings. When recording or playback is done, the settings in the Audio Mixer are restored. DVK mixer settings are not stored with presets but in the message banks. This means each bank can have its own levels (slider position). It also allows each bank to be configured for the voice of a different operator if micro KEYER III is used in a club station or other multi-operator situation.

DVK memories can be recorded or played under logger control if your logger supports *microHAM* Control Protocol.

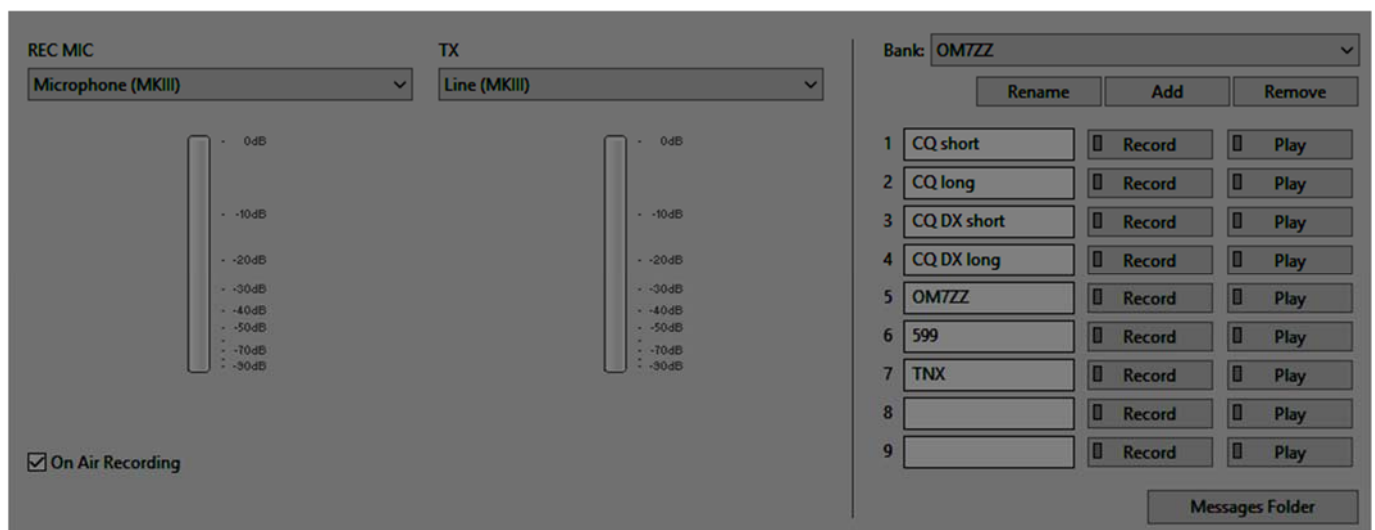

For proper DVK functionality it is necessary to correctly assign input and output audio devices. For a recording microphone REC MIC set Microphone device of MKIII and for TX output Line of MKIII.

REC MIC: "Microphone (MKIII)"

TX: "Line (MKIII)"

If "On Air Recording" box is checked, the microphone is connected to both the sound card and the transceiver input while messages are being recorded.

KEYBOARD TAB

The Keyboard Tab controls the operation of a PS/2 keyboard or numeric keypad connected to the PS/2 jack. It is also possible to define control functions for the numeric keypad. Custom controls are invoked by pressing and holding the asterisk key (*) with Numkey0-9.



General:

QWERTZ layout – configures the keyboard for a QWERTZ layout.

AZERTY layout – configures the keyboard for a AZERTY layout.

FSK from keyboard:

Diddle LETTERS: send the LETTERS character whenever there is nothing in the transmit buffer.

UOS: shift back to LETTERS case whenever a space is encountered in the transmit data.

Type ahead: enables type ahead when using a PS/2 keyboard. Characters are transmitted after a *space* (word mode) or when the buffer has reached its limit (16 characters).

CW from keyboard:

Type ahead: enables type ahead when using a PS/2 keyboard. Characters are transmitted after a *space* (word mode). or when the buffer has reached its limit (16 characters).

Speed Step: set the amount by which the Up/Down or NUM +/- keys change the CW speed.

Auto numbering: Allows to configure standalone contest number reports.

Leading zero as T: sends leading zeros in contest report as T. For example 001 will be send as TT1.

Zero as T: sends all "zeros" in contest report as T. For example number 100 will be send as 1TT.

One as A: sends all "ones" in contest report as A. For example number 101 will be send as A0A.

Nine as N: sends all "nines" in contest report as N. For example number 199 will be send as 1NN.

Report 5NN: send 5NN before contest serial number.

The PS/2 and FH-2 sub tabs allow assigning control functions to PS/2 and FH-2 style keypads. FH-2

connects to pins 2 and 3 of the PS/2 jack. microHAM does not supply adapter for FH-2 keypad.

NOTE: FH-2 cannot be connected to the transceiver and to the MKIII at the same time but PS/2 keyboard/keypad and FH-2 keypad can be both connected to MKIII at the same time. Use PS/2 splitter cable available in computer's accessories shops.

NOTE: The keyboard/keypad must be PS/2. A USB device with PS/2 adapter will usually not work.

micro KEYER III includes the ability to generate FSK or CW, record and play CW, FSK or VOICE messages using a PS/2 keyboard or numeric keypad connected to the PS/2 jack. A numeric key pad is sufficient to record and play CW and DVK messages, control CW speed (WPM) or play a serial number message. "Live" CW or FSK (RTTY) requires a full keyboard.

Switching modes:

The keyboard or keypad mode will follow the mode of the transceiver with Transmit Focus. If the radio is not computer controllable or its control protocol is not supported, the keyboard or keypad can be used to switch Router's operating mode if the "radio" selection is "no radio (mode selected manually)."

Playing messages:

A message is started by pressing F1-F9 on the keypad or 1-9 on the number pad. A message can be aborted with the ESC key or the zero key on the number pad. Messages may be made to repeat (loop) by pressing DEL (period) on the number pad while the message is playing. The default (minimum) wait time after ending a message and starting again is one second. The pause time may be set from 1 to 9 seconds by entering the desired delay immediately after pressing DEL. For example, 1 5 will start message number 1 and cause it to repeat with five a second delay. Pressing zero (0) will terminate a message loop.

STATUS INDICATION				
NUM	CAPS	SCROLL	play/rec	mode
OFF	x	x	playback	
ON	x	x	recording	
x	OFF	OFF		CW
x	OFF	ON		DIGITAL
x	ON	OFF		FSK
x	ON	ON		VOICE

Recording messages:

Recording is started (and stopped) by pressing NUM LOCK. To start recording, press NUM LOCK followed by the number of the message to be recorded. To abort a message without saving, press zero on the number pad or Escape. To end recording and save the message press NUM LOCK.

In CW, micro KEYER III stores characters as they are echoed from the internal WinKey2: only those characters actually transmitted are stored. However, CW messages may be recorded from either paddles or the keyboard. The gap "j" and other WinKey commands cannot be entered from the keyboard but may be used in messages loaded from Router's CW/FSK Messages tab.

In FSK, all characters entered from the keyboard are stored.

<i>std. key</i>	<i>Numeric Keypad</i>		<i>CW mode</i>	<i>FSK mode</i>	<i>Voice mode</i>
	NUM LOCK	start/stop recording of message (recording mode is indicated by NUM LED)	✓	✓	✓
	NUM *	Tune (can be canceled by keys NUM 0 or ESC, or by the paddle)	✓		
ESC	NUM 0	playback: stop transmitting (message or any characters in buffer)	✓	✓	✓
		recording: abort recording without storing the message			
F1-F9	NUM 1 – NUM 9	playback: start message playback	✓	✓	✓
		recording: set message number			
	NUM DEL	playback: periodically repeat last message (default interval is 1 second, it can be changed by pressing the number on number pad)	✓	✓	✓
		recording: no function			
	NUM /	Switch between "speed control mode" and "serial number mode" (serial number mode is indicated by SCROLL LED, if present)	✓		
ALT		When held allows setting the serial number			
PG UP	NUM +	WPM control	Increase CW speed (step defined by configuration)	✓	
UP		S/N mode			

PG DN	NUM -	WPM control	Decrease CW speed (step defined by configuration)	✓		
DN		S/N mode	Decrement number by one	✓		
HOME	NUM ENTER	WPM control	Reset CW speed to pot (knob) value	✓		
ENTER		S/N mode	Transmit number with optional report and increase number by one (format defined by configuration)	✓		
ENTER			transmit CR and LF characters		✓	
F10			Toggle PTT – alternative to foot switch	✓	✓	
CAPS LOCK			Switch between CW mode and FSK mode (FSK mode is indicated by CAPS LED)	✓	✓	
SPACE			transmit space (if "type ahead" mode is active all buffered characters are transmitted before this space)	✓	✓	
			transmit gap (one-half dit delay time), this character cannot be recorded to a message from keyboard – it may only be entered from Router	✓		
0-9 a-z "#\$%&'()*+,-./:;<=>?@\			transmit character, if "CW type ahead" mode is active character is pushed to type ahead buffer to be transmitted after next space. Note: some special characters are mapped to standard prosigns (see WinKey manual)	✓		

0-9 A-Z !"#\$%&'(),-./:;?	transmit character, if "FSK type ahead" mode is active character is pushed to type ahead buffer to be transmitted after next space		✓	
---------------------------	------------------------------------------------------------------------------------------------------------------------------------	--	---	--

Using The FH-2 (RESPAD) Input For Simplified Device Control

In several microHAM devices, many of the functions can be conveniently controlled by an attached PS/2-type keyboard or numerical keypad. Functions attached to individual keys can be configured from the Keyboard sub-tab of the device's tab in Router.

However, it is sometimes desirable that one or a few of the functions are controlled by a simple pushbutton or a footswitch. For example, when operating within a relatively narrow frequency range, it might be desirable to suppress minor retunes of an attached stepping antenna, which would disable transmission when the frequency is changed across the antenna's tuning boundary. Stepping antenna control can be toggled on/off by pressing one of the keypad buttons. Several similar functions are available.

For such simple control purpose, a less-known feature of some of the microHAM devices - an input for attaching a simple resistive keypad - can be employed. This feature is present on the following devices:

micro KEYER III, micro KEYER II, micro2R (u2R), Digi Keyer II, Station Master, Station Master DeLuxe

This feature was designed with the FH-2 type keyboard in mind, which is a simple resistive keyboard, where pressing a key results in connecting the input through a resistor to ground. However, this keyboard is equipped by a standard mono 3.5 mm jack, so using it requires either to change the jack for a miniDIN6 connector, or to build a simple adapter.

The keypad is to be connected between pin 2 (RESPAD) and pin 3 (GND) on the PS/2 connector. The following values of resistance correspond to individual keys on the FH-2 keyboard:

Key	Resistance	Pin #	Label	Description
1	910 Ω	1	DATA	TTL PS/2 DATA line
2	1,3 kΩ	2	RESPAD	Input for resistive keypad, max. +5V/1mA
3	1,8 kΩ	3	GND	Connected to the system ground and case.
4	2,4 kΩ	4	+5V OUT	+5V output, max.200mA.
5	3,3 kΩ	5	CLOCK	TTL PS/2 CLOCK line
6	4,3 kΩ	6	NC	Not connected
7	5,1 kΩ	SHELL	GND	Connected to the system ground and case.
8	6,8 kΩ			
9	9,1 kΩ			
10	16 kΩ			
11	12 kΩ			
12	24 kΩ			

So a simple control could be build by putting a resistor of one of the values from table above in series with a switch, connected between pins 2 and 3 on the

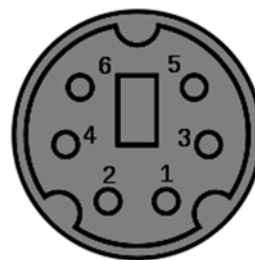

Front view of miniDIN6 male connector

PS/2 connector. Use a 5% or better precision resistor. As cable-mount miniDIN6 male connectors are relatively hard to obtain, you can purchase and cut to half a PS/2 mouse or keyboard extension cable, which are widely available as computer accessory.

Finally, on Keyboard tab select the FH-2 controls. Then set the desired function for key respective to the resistor value used. Finally, store the selection through Menu | Device | Store as Power-up Settings, so that the switch can be functional also when the device is used standalone, without Router running on PC.

DISPLAY TAB

The display tab provides controls for configuring the micro KEYER III left display.

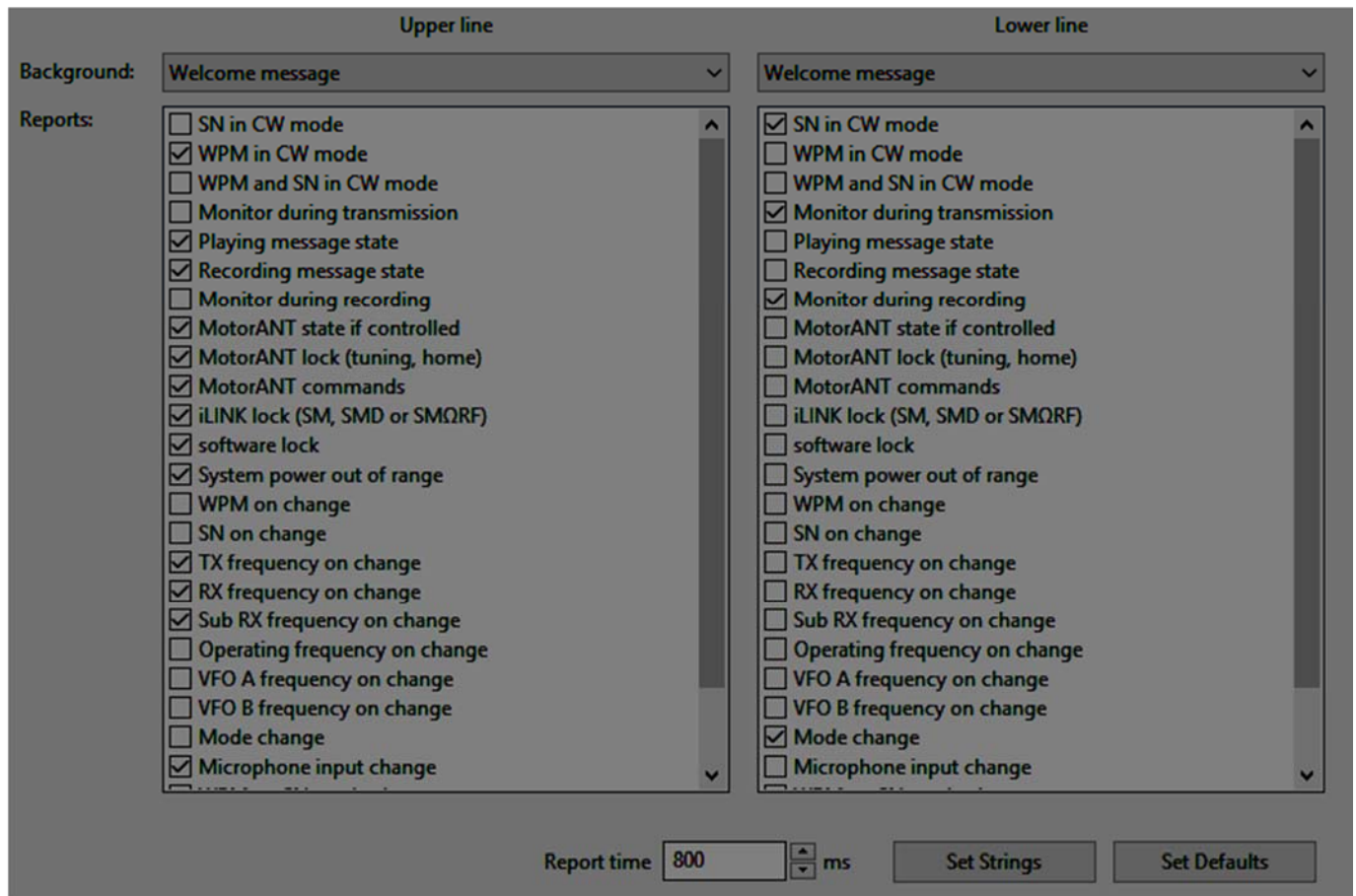

Each line can display one default (background) function and any of “temporary” status reports. The “background” functions are those that appear at idle. The status messages appear depending on operating mode.

Report time: Sets the length of time that transient (status change) reports remain visible

Set Strings: Set the “Welcome Message” to be displayed when micro KEYER III is initialized.

Set Defaults: Returns the display to factory settings

SYSTEM SETTINGS TAB

System Power: Displays the voltage at the +13.8 VDC input jack.

Enable sleep mode:

When checked, micro KEYER III will sleep when the power to DB37, pin 1 is turned off and Router is not running.

CI-V port settings:

The CI-V port will emulate an Icom transceiver regardless of what transceiver model is connected to MKIII and “broadcast” the frequency and mode data in Icom format if Router can determine them by polling the radio or reading polling data from the logging program. The transceiver broadcast can be used to control peripherals like Power Amplifier or Automatic Antenna Tuner that use Icom protocol.

The screenshot shows the SYSTEM SETTINGS TAB interface. It is divided into four sections:

- System power:** Shows '12.9 V OK' and an unchecked checkbox for 'Enable sleep mode'.
- CI-V port settings:** Includes a 'Function:' dropdown menu set to 'TX frequency', a 'Baud rate:' dropdown menu set to '9600 bps', and an 'Address:' text box containing '6A'.
- iLINK port settings:** Shows 'firmware v0.0' and a 'Function:' dropdown menu set to 'Auxiliary port', with a 'Baud rate:' dropdown menu set to '4800 bps'.
- iLINK coupling:** Includes an 'SM:' dropdown menu set to 'none' and an 'SMORF:' dropdown menu set to 'none'.

There are six frequencies which can be broadcast: Operating frequency, VFO A frequency or VFO B frequency, TX frequency, RX frequency, or Sub RX frequency. In practice, operation of each setting depends on the transceiver and its CAT protocol. All options may not work with some transceivers.

Baud Rate: Sets the Baud rate for the CI-V broadcast

Address: Sets the “simulated Icom radio” CI-V address for the CI-V broadcast

iLink port settings: Sets the function of the TTL serial lines on the iLink connector. The iLink Port supports two optional functions: **Auxiliary Port** or **Antenna Control**.

NOTE: Connecting micro KEYER III to an antenna controller or auxiliary RS-232 device requires a TTL to RS-232 converter like the [microHAM iLINK-UltraBeam](#) or [iLINK-SteppIR](#). Pin-out documentation for the iLINK port can be found in Appendix A.

Auxiliary (general purpose) serial port: When the iLINK port function is set to Auxiliary port, data is transferred between the “Auxiliary” virtual port defined on Ports tab and the iLINK serial lines without modification. Maximum data rate is 19200 Baud.

Antenna Control: micro KEYER III can control SteppIR and Ultra Beam antennas using the antenna's native protocol. For connection information see your antenna's manual.

Native mode control has two advantages over control based on transceiver frequency only.

- 🔒 micro KEYER III protects the antenna while elements are moving (retuning). Transmission can not be initiated using PTT while the antenna is retuning. When using VOX, micro KEYER III will not activate PA PTT to prevent a power from amplifier while antenna is tuning.
- 🔒 When operating in split frequency mode, the transmit frequency is sent to the antenna to prevent retuning between transmit and receive when operating with wide splits.

NOTE: This function does not replace the OEM controller, the original controller is still used.

IMPORTANT: The original SteppIR controller MUST be switched into the GENERAL mode. Manual band changes on controller front panel are disabled. Autotrack must be turned on with the SDA-100. Use 9600 Baud or lower for reliability. For UltraBeam antenna Baud rate must be set to 19200 Baud.

13 - ROUTER MENU ITEMS DESCRIPTION

ROUTER MENU

Default Router Settings: Used to completely reset Router to factory (default) settings. "Default" removes all device tabs and deletes all stored configuration data, including all user presets. from the Windows Registry.

TIP: micro KEYER III can be reset to the factory configuration by selecting **Default Router Settings** followed by **Device | Store as Power-up Settings** to save the defaults to the keyer's memory.

Restore Router Settings: Used to restore settings from a urs file created by the backup command. A urs file can be used only with the device for which it was generated (the file contains the unit's serial number) on a computer with same port assignments.

WARNING: Restoring a backup deletes all current Router settings including presets, **use it carefully!**

Backup Router Settings: Used to create backup urs file. This file contains Router settings (including Presets) for all devices defined in Router.

Options | General:

Load Router on Start-up: When checked, Router will start automatically each time the computer is started or rebooted.

Start Router Minimized: When checked, Router will started minimized

Options | Band Map: (Not used in micro KEYER III)

Options | Digital Band Map: Customizable band limits for digital mode operation. This setting is used to automatically select VOICE or DIGITAL audio switching and the proper PTT output (PTT1/PTT2). The boundaries are necessary for transceivers which do not have a special mode for AFSK operation or do not provide this information via computer control. This primarily effects Kenwood and Ten-Tec transceivers although it is also applicable to some older Icom and Yaesu radios.

Options | Audio Devices:

Don't use audio devices: When checked, Router does not use audio devices and the settings on the DVK tab have no effect.

WARNING: When selected, Router will not be able to control DVK, **use it carefully!**

Manually assign audio devices: when checked, Router will allow the user to select audio devices (sound card) in the appropriate fields and will actively control the audio devices.

Automatically assign microHAM audio devices: (Not used with micro KEYER III)

Options | DVK:

Voice message time limit: Maximum time for each voice message up to 120 seconds.

Sample rate: Sampling frequency used during recording and playback of voice messages.

Sample size: Sampling size used during recording of voice messages. Sampling size primarily effects audio quality of the messages. 16 bit samples provide higher quality than 8 bit.

NOTE: Select the same sample rate and size as used by your software (logger) to avoid message distortion.

Options | USB:

Noise immunity: Selects how many times an undelivered USB packet will be repeated before the USB device is disconnected from the operating system.

Response time: Selects how long the USB interface will wait for additional data before sending data to the operating system.

Minimize: Clicking this will minimize Router to the system tray at the bottom right corner of the Windows Task Bar (the "System Notification Area").



TIP: When Router is minimized you can restore it by double-clicking on the Router tray icon. You can also restore Router by double-clicking on the Router icon on the desktop or in the Programs menu.

Exit: Clicking on this item will terminate Router.

IMPORTANT: when Router is terminated the virtual ports will be closed and application software will be unable to communicate with micro KEYER III and the radio.

PRESET MENU

The requirements of each application (logging, control and digital mode programs) are different. Each program handles radio control, CW, FSK, PTT, and the sound card its own way. In some cases, what works for one application may not work properly with another. To get maximum performance from micro KEYER III, the user should create customized settings for each application used.

For easy switching among applications, Router supports up to 12 user definable **Presets**. Different configurations can be stored in these presets and recalled almost instantly simply by clicking on the preset button.

Each preset contains the settings for all devices connected to, and controlled by, Router. For example, if Router controls a micro KEYER III, a USB Interface II and Station Master, each preset remembers the settings for all devices including the assignment of COM ports and the contents of all sub-tabs except the FSK/CW Messages and DVK tabs.

NOTE: Presets are not available until they have been created and saved by the user using **Preset | Save as**. For sample configurations for popular software, refer to the Setup Guide documents available in Router Help menu. Use **Help | Download Documents** if the Setup Guides are not available or incomplete.

There are three ways to apply a preset once it is created:

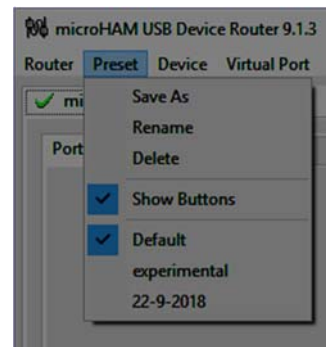

1.C
lick on **Preset** and select from the pull-down menu.

2.C
lick on a preset button. For the buttons to be visible in Router, **Preset | Show Buttons** must be checked.

When the settings from a preset are applied, a green light located in the preset button is lit. This green light is on ONLY when all settings in Router are same as those stored in the preset.

3. B
 y right clicking on the system tray icon when the Router is minimized.

4. T
 he presets and the current router configuration are stored to the registry when Router is closed and

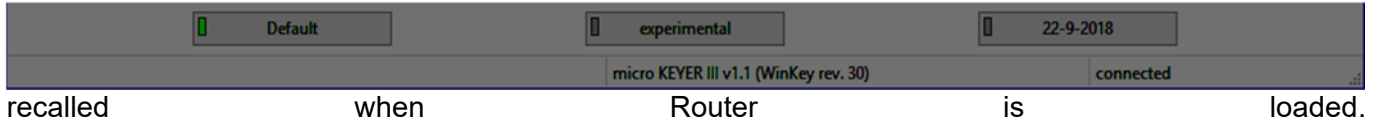

Save as: Saves the current Router settings to a preset for future use.

Rename: Allows renaming of an existing preset.

Delete: Delete chosen preset.

Show buttons: When checked, Router shows the preset buttons.

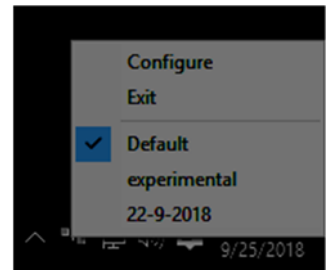

DEVICE MENU

Router can control several devices. This allows configuring the settings for all (interfaces) connected to the computer at the same time using the Presets.

Each device has its own tab (page) in the main Router notebook. The content of each device tab depends on the type of device. Adding a device is automatic when Router detects a new device. Once detected, a device remains in Router even though device is disconnected. Each device is identified by a unique serial string.

NOTE: Router supports all microHAM USB devices in a single instance by creating a separate root tab for each device. It is not necessary to run multiple instances of Router; a secondary instance can not be started.

Rename: Creates a custom device name. This is useful if two or more devices are connected to the Router. For example micro KEYER III and micro KEYER II can be renamed to more identifiable names as shown here...

Delete: Removes a device from the Router. Only devices that have been disconnected (those with a **RED "X"** on device tab) can be removed. To disconnect a device from Router, unplug the USB cable.

Save Template: Will save the current Router settings to template file.

When clicked, Router will open a standard File Save dialog window – the default location is *C:\Documents and Settings\All Users\Application Data\microHAM\cfg*. If a hypertext (*html*) or plain text (*txt*) documentation file of the same name as the template is present in the same directory, it will be associated with the template.

Load Template: Will automatically configure Router from a template (*.tpl file).

When clicked, Router will open a standard File dialog – the default location is: *C:\Documents and Settings\All Users\Application Data\microHAM\cfg* - and the desired template can be chosen.

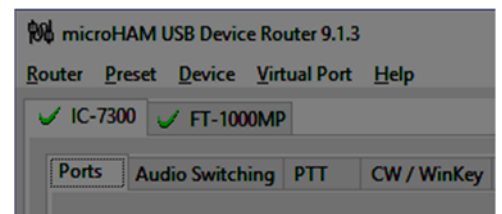

When Router loads a template, it looks for an html or txt file with the same name as the template in the same directory. If such file is found, it is displayed.

TIP: Templates are a powerful tool for quickly configuring Router to work with a particular application. Template files are interchangeable between computers and ideal for cloning setups in multi-computer stations or for sharing configurations between users.

Store as Power-Up Settings: Will store the current settings of the Audio Switching, PTT, CW/WinKey, Keyboard, Display and System tabs to the micro KEYER III EEPROM. If micro KEYER III is operated without connection to the computer it will use the settings stored in EEPROM. If micro KEYER III is connected to a computer running Router, the Router settings will be used instead EEPROM settings but the power up settings are retained in EEPROM.

Upload Firmware: microHAM will occasionally release updates to the firmware in micro KEYER III. The update may support new features in Router or improve application compatibility. To update firmware, click on **Device | Upload Firmware**. A Windows file dialog will open, navigate to the directory where firmwares are located, by default: Program Files (x86)\microHAM\firmware\.

NOTE: When upgrading Router, the upgrade **will** include the latest firmware for micro KEYER III. If the firmware is newer than the currently installed firmware, Router will automatically ask for permission to update the installed firmware the first time it connects to micro KEYER III.

VIRTUAL PORT MENU

Virtual ports are created and deleted from the Virtual Port menu located on top Router's menu bar.

Create Port: Creates virtual COM ports. It is possible to select more than one port at a time by checking appropriate boxes. Creating virtual ports may take a long time (several tens of seconds), be patient.

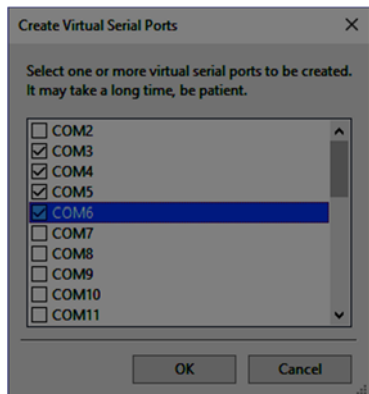

DO NOT define a port that is already in use (for example, COM1 or COM2 which are hardware ports on some motherboards) or a virtual port that is already used by another USB device. Even though Router will not allow creating a virtual port on a COM port number which is currently present in the system (like hardware COM ports or internal modems), sometimes these ports are hidden. If another device that also uses virtual ports (external USB devices, bluetooth devices, mobile phones, PDAs etc.) is not connected when creating virtual ports in Router, the ports can overlap and will not work properly when you connect such device.

IMPORTANT: Before you begin to create virtual ports, attach all external devices you are using with computer and allow them to be connected to the system. Restart Router and then create virtual ports.

Delete Port: Deletes any single virtual port.

Delete All: Deletes all previously created virtual ports.

Do not delete a virtual port until all applications using that port have been closed.

Show All: Shows all COM ports existing in operating system, already existing ports, all created virtual ports, created virtual cable and bridges.

Cables & Bridges

Cables (software “null modem” cable) create interconnected virtual ports transferring data in both direction, which can be configured as a point to point pair like com0com, or point to multi-point (star, splitter or combiner) like VSPE or bus. Applications may connect to each other using cables. For example, the Secondary CAT Serial Port in DXLab Suite's Commander may connect to one end of a cable and a software panadapter might connect to the other end of the cable.

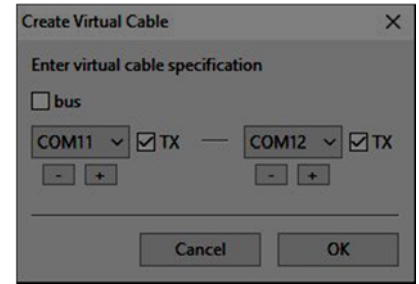

NOTE: Cables can not connect to any port used in Router's Ports tab.

The TX check box designates the port as a bidirectional port – the TxD line is active/connected. If the TX box is unchecked, the port is a "receive only" (listen) port like the “listen” leg of the "Y" cable used between a computer serial port and transceiver for devices like a SteppIR controller, "AT-Auto" tuner or some automatic power amplifiers. With +/- buttons can be added additional ports in order to create COM port splitters and combiners.

IMPORTANT: Created splitters and combiners are not managed, in other words not aware of data content they are transferring, same as VSPE or any other unmanaged splitter/combiner. Contrary to managed Router's CAT / 2ndCAT splitter/combiner which is CAT protocol aware and can merge and distribute data according to particular CAT protocol structure, data obtained with not managed splitters/combiners have no guarantee of keeping packet structure and merged result can be confusing for device receiving data. It's like as if you would hear two persons speaking at the same time and you should write what they speak without thinking. Without synchronization between them, your written text will be a meaningless sequence of correct words, instead of logical sentences each were saying. Same applies to combiner, while separate data will have correct packets format, merged data will have corrupted packet structure very soon. Use with care!

Bridges (straight “extender” cable) allow connecting any two (existing) ports - serial port to serial port, serial port to virtual port (cable), or virtual port (cable) to virtual port (cable). Bridge “opens” two ports at selected Baud rate and data length/parity, similar as any Windows application and transfers data from one end to another, even at different speed for each end.

NOTE: Bridges can not connect to any port used in Router's Ports tab.

Create Cable: Creates virtual null modem cable, splitter/combiner or bus.

Delete Cable: Deletes specified virtual cable.

Create Bridge: Creates virtual data bridge between two existing COM ports.

Delete Bridge: Deletes specified bridge.

The only purpose of cables and bridges is to replace third party software serial splitters or software null modem connections like Com0com, DDutil, LP-Bridge, VSPE, etc. that may conflict with the Eltima VSPAX drivers used by *microHAM* USB Device Router. In this regard, *microHAM* USB Device Router provides a means to enable and configure the capabilities that exist in the Eltima VSPAX product.

HELP MENU

Manuals: Link to *microHAM* manuals located on your system.

Setup Guides: Link to software configuration guides for many common applications.

Cable Schematics: Link to cable diagrams.

Download Documents: Downloads *microHAM* documentation including updated manuals and setup guides. You may specify the products for which you want documentation.

NOTE: Requires an Internet connection.

microHAM Home Page: Link to www.microHAM.com

microHAM Downloads Page: Link to www.microham.com/contents/en-us/d29.html

Show Tooltips: When checked, small, single line help is displayed below the mouse cursor.

Update Router: Download and install the most recent version of Router.

About: Shows the Router's internal version number and drivers version.

Change logs: Shows the Router and firmware changes.

14 - SYSTEM CONSIDERATIONS

micro KEYER III can be used with a wide variety of software. The capabilities of those packages will have large influence on the level of computing power needed to utilize *micro KEYER III*.

When used with Windows based contest logging applications like N1MM Logger Plus, Win-Test, DXLog.net and WriteLog or Windows based general logging applications like DXLab Suite, DX4Win, Logger 32 and others, the *microHAM* control and interface application "*microHAM Router*" must run with the application. Since both the logging program and *microHAM Router* are real-time applications, system performance will be dependent on both CPU speed and the amount of available RAM.

While *microHAM Router* may run on slower computers, the minimum tested system is a 1.1 GHz dual core processor, Windows 7, 2 GB RAM, and USB 2 port. Whether Router can run as designed on slower machines with less memory and leave enough resources for application programs has not been determined.

In order to provide sufficient performance for simultaneous operation of *microHAM Router*, a logging application, Internet connectivity and other accessory programs, the recommended system is a 2 GHz or faster multi-core CPU with Windows 7 or later, 4 GB RAM, root USB 2.0 port, and a transceiver with supported control protocol and logger, control, or digital mode software.

15 - HARDWARE SPECIFICATIONS

USB:	USB 2.0 Full speed, isolated FTDI USB – serial UAC1 asynchronous downstream, max. 24-bit/48kHz asynchronous/synchronous upstream, max. 24-bit/96kHz
Power consumption:	USB – less than 10mA Power supply – max. 450mA @ 13.8VDC (max.16VDC)
Radio Port:	RxD, TxD – max. 57600 Baud, RTS/CTS handshake supported Levels: FIF-232, IF-232, CI-V, RS-232
Aux Port:	TTL – RxD, TxD, no handshake – max. 19200 Baud
CI-V Port:	open collector bus – max. 19200 Baud
CW:	open collector, max 30V/400mA
FSK:	open collector, max 30V/400mA 5/6/7 bit data, 1/1.5/2 stop bits, up to 300 Baud
PTT1:	open collector, max 30V/400mA
PTT2:	open collector, max 30V/400mA
PA PTT:	optoMOS, max. 300VAC/VDC @ 0.1A
LNA PTT:	optoMOS, max. 300VAC/VDC @ 0.1A
Foot Switch:	active when closed to ground, max load: 1 mA at 5V
PTT IN:	active when closed to ground, max load: 1 mA at 5V
Monitor:	Mono, 1 Watt @ 4 Ohm speaker
Audio Line Output:	600 Ohm, max. 1.5Vp-p AC coupled
Audio Mic Output:	600 Ohm, max. 370mVp-p AC coupled
Audio Line In:	10K Ohm, max 5Vp-p dual channel (Stereo) Dynamic Range: min. 105dBA, typ. 110dBA THD: 0.0009% IMD+Noise: 0.004% AC coupled
Dimensions:	W 232mm (9.125") x H 44mm (1.73") x D 105mm (4.125")
Weight:	1.3 kg (1.875 lbs.)

16 - PACKAGE CONTENTS

The product includes micro KEYER III, USB cable, 3.5 mm audio cable (sub-receiver audio), RCA to RCA cable (PTT IN), coaxial 2.1mm/5.5mm power plug, and RJ-45 – Foster 8 microphone adapter.

If the shipment is incomplete, please contact your supplier or us at the following address:

E-mail: support@microham.com

fax : +421 2 4594 5100

by Post: microHAM s.r.o.
Nadrazna 36
90028 Ivanka pri Dunaji
SLOVAKIA

17 - WARRANTY

microHAM warrants this product for two (2) years. The product must not be modified in any way or the warranty is voided. Cables are warranted against defects in materials and workmanship for a period of 60 days.

What is covered: During the warranty, microHAM, s.r.o., will repair or replace defective product at their sole discretion. You must send the unit postpaid with a copy of the original invoice to the distributor from whom you purchased the product. microHAM will pay return shipping.

What is not covered: This Limited Warranty does not cover (1) correction of installation or software errors in the user's computer(s), (2) damage caused by misuse, negligence, user modifications or failure to follow the user manual, (3) connection to improper or excessive voltage or voltage surges, (4) the incorrect installation of any cables connected to the device by the user or (5) weather related storm, lightning or electrostatic discharge damage.

microHAM USB Device Router (the software) is provided “as is” without guarantee of compatibility with any specific operating system, computer, peripheral or accessory.

microHAM assumes no liability or responsibility for damage to other devices or injuries to persons as a consequence of using our products.

If the terms of the above warranty are not acceptable, return the unit, all associated documents and accessories in the original unopened package, prepaid, to microHAM or to your supplier for refund less shipping and a restocking fee.

DECLARATION OF CONFORMITY



Federal Communications Commission Statement (USA)

This device complies with Part 15 of the FCC Rules. Operation is subject to the following two conditions: (1) this device may not cause harmful interference, and (2) this device must accept any interference received, including interference that may cause undesired operation.



European Union Declaration of Conformity

microHAM, s.r.o. declares that the products:

Product Name: micro KEYER III

Conforms to the following Product Specifications:

EN 55032: 2015

Compliance with this standard provides presumption of conformity with the specified essential requirements of EC Directive 2004/108/EC (EMC Directive) and EC Directive 1999/5/EC (R&TTE Directive).

APPENDIX A – CONNECTORS

RADIO – DB37

Pin #	Label	Description
1	POWER	Auxiliary 12V power input
20	RS232 RTS	RS232 radio port RTS output
2	RS232 CTS	RS232 radio port CTS input
21	IF-FIF	iface matrix - used for configuring desired levels for radio control interface
3	IF IN	iface matrix - used for configuring desired levels for radio control interface
22	FIF IN	iface matrix - used for configuring desired levels for radio control interface
4	RS-TTL OUT	iface matrix - used for configuring desired levels for radio control interface
23	FILTER OUT	iface matrix - used for configuring desired levels for radio control interface
5	CI-V IN	iface matrix - used for configuring desired levels for radio control interface
24	RS232 IN	iface matrix - used for configuring desired levels for radio control interface
6	CI-V OUT	CI-V bus output "open collector"
25	RS232 OUT	RS232 TXD output
7	FIF OUT	FIF-232 TXD output "TTL"
26	IF OUT	IF-232 TXD output "TTL"
8	FILTER IN	RXD input for all interfaces
27	PTT1	PTT1 output "open collector" generally used as all mode front panel MIC PTT
9	PTT2	PTT2 output "open collector" generally used as rear panel digital modes PTT
28	CW OUT	CW output "open collector"
10	PULL UP	+5V through a 10K resistor
29	FSK OUT	FSK output "open collector"
11	FSW IN	Hand Mic PTT input
30	MIC #1	RJ45 Microphone jack pin #1
12	MIC #2	RJ45 Microphone jack pin #2
31	MIC #3	RJ45 Microphone jack pin #3
13	MIC #4	RJ45 Microphone jack pin #4
32	MIC #5	RJ45 Microphone jack pin #5
14	MIC #6	RJ45 Microphone jack pin #6
33	MIC #7	RJ45 Microphone jack pin #7
15	MIC #8	RJ45 Microphone jack pin #8
34	MIC GND	Microphone ground
16	MIC	Microphone signal
35	RADIO MIC IN GND	Radio MIC ground
17	RADIO MIC IN	Radio MIC signal
36	RADIO AF IN GND	Radio AUDIO input ground
18	RADIO AF IN	Radio AUDIO input signal
37	RADIO AF OUT GND	Radio AUDIO output ground
19	RADIO AF OUT	Radio AUDIO output signal
SHELL	GND	Radio and power GND

iLINK – miniDIN 6

Pin #	Label	Description
1	DATA	I2C Data (TTL)
2	RX EXT	Serial Data In (TTL)
3	GND	Connected to system ground and case
4	+5 V	+5V output, max.100mA.
5	CLOCK	I2C Clock (TTL)
6	TX EXT	Serial Data Out (TTL)
SHELL	GND	Connected to system ground and case

PS/2 – miniDIN 6

Pin #	Label	Description
1	PS/2 DATA	TTL PS/2 DATA
2	RESPAD	Input for resistive keypad (FH-2), max.+5V/1mA
3	GND	Connected to the system ground and case.
4	+5 V	+5V output, max.100mA.
5	PS/2 Clock	TTL PS/2 CLOCK
6	n/c	Not connected
SHELL	GND	Connected to system ground and case

APPENDIX B – RFI Considerations

A few guidelines to eliminate problems caused by RFI:

1. Proper grounding of all electronic equipment is critical. A modern station contains many, diverse, types of interconnected and interrelated equipment: transceiver, power amplifier, computer, control boxes, switch boxes, and power supplies. Each of these must be individually grounded with a separate connection to a single common ground point, thus forming a star ground connection.

Proper grounding of computers, both "desktop" and laptop is often overlooked. A separate ground connection should be run from the computer to the station common ground point. The best place to ground a computer is a screw with a good connection to the case. On a laptop, this is often the retaining screw on a D-sub connector (e.g, VGA output); on a "desktop" it is often the screws holding the power supply.

It is absolutely important to prevent ground currents from flowing to the common ground point by way of the signal cable. If you use a microHAM "keyer," a good test is to remove the DB15/DB37 connector and USB cable from the keyer and measure the resistance from the shell of the DB15/DB37 to the shell of the USB cable. There should be NO MORE than FIVE (5) Ohms (and preferably less than TWO Ohms) between them.

Note: many PC manufacturers fail to provide an adequate connection between the shell of the USB connector and the PC case. If this is the case, a connection can be established by bridging a folded piece of aluminum foil between the shell of the USB connector and the PC case.

2. Power all your equipment from a single wall outlet. The "safety ground" often exhibits excessive noise between power outlets - often due to other equipment powered from the same branch circuit. It is always better to avoid this source of noise/interference. It is also a good idea to check the power distribution for loose connections, reversed neutral/ground, open ground and other wiring problems.
3. Sometimes, the USB cable can be a source of RF interference - the cable might have inadequate shielding or the data transceivers in PC might be improperly designed causing data flowing inside the cable to be reflected as a common mode current on the shield of the cable. This common mode current can radiate a significant "digital noise." If this is the source of your problems, it can be significantly reduced or eliminated using ferrite chokes on both ends of the cable. Two or three turns through a #31 mix toroid are better than the common snap-on ferrites of unknown mix.
4. Often, another cause of RFI problems is a common mode current flowing along the antenna feedline into the shack. It is a common misconception that the only thing required of a feedline is that it have low SWR. Unfortunately, a low SWR does not guarantee low common mode current. These common mode currents are conducted into the shack where they can radiate from the feedline, induce currents in any nearby metal object, and/or be conducted into the interconnected equipment. Common mode currents on a feedline are indicated by problems that differ in intensity from one band to another or from one end of the band to another, by problems that change when a feedline is moved or its length changed, where the problem moves from one piece of equipment to another based on band, and/or where the severity changes with transmit power level. The solution is to use common mode chokes to prevent the current from entering the shack. This topic has been given thorough treatment in recent works by W1HIS and K9YC.

W1HIS: <http://www.yccc.org/Articles/W1HIS/CommonModeChokesW1HIS2006Apr06.pdf>

K9YC: <http://www.audiosystemsgroup.com/RFI-Ham.pdf>