

# *micro*KEYER II



***micro*HAM**

fax: +421 2 4594 5100  
e-mail: [support@microham.com](mailto:support@microham.com)  
homepage: [www.microham.com](http://www.microham.com)

Version 7.7  
5 December, 2010

## TABLE OF CONTENTS

<b>CHAPTER</b>	<b>PAGE</b>
<b>1. FEATURES AND FUNCTIONS .....</b>	<b>3</b>
<b>2. IMPORTANT WARNINGS .....</b>	<b>4</b>
<b>3. PANEL DESCRIPTION .....</b>	<b>5</b>
Front Panel .....	5
Rear Panel .....	6
<b>4. INSTALLATION .....</b>	<b>8</b>
Preparing microKEYER II for Use.....	8
Macintosh (OS X) Installation.....	9
Windows (Windows 2000, XP, Vista & Windows 7) Installation .....	10
Installing microHAM USB Device Router .....	10
Configuring microHAM Codec .....	11
Configuring microHAM USB Device Router .....	12
Creating and Using Virtual Serial Ports .....	13
<b>5. <i>microHAM</i> DEVICE ROUTER .....</b>	<b>14</b>
Menu: Router .....	14
Menu: Preset .....	15
Menu: Device .....	16
Menu: Virtual Port .....	18
Menu: Help .....	18
Device Configuration Tabs .....	19
Ports Tab .....	20
Ports: CAT & 2nd CAT .....	21
Ports: FSK & 2nd FSK .....	24
Ports: CW .....	25
Ports: PTT & 2nd PTT .....	26
Ports: Foot Switch .....	26
Ports: WinKey .....	27
Ports: Auxiliary .....	28
Ports: Control .....	28
Audio Switching Tab .....	29
Audio Mixer Tab .....	32
PTT Tab .....	37
CW/WinKey Tab .....	38
CW Messages Tab .....	39
FSK Messages Tab .....	40
DVK Tab .....	41
Keyboard Tab .....	42
Display Tab .....	43
System Tab .....	44
<b>6. Setting Audio Levels .....</b>	<b>45</b>
Configuring microKEYER II for your radio .....	45
Setting audio levels in Windows 2000 and Windows XP .....	45
Setting audio levels in Vista and Windows 7 .....	47
<b>7. System Considerations .....</b>	<b>48</b>
<b>8. External Keyboard/Keypad .....</b>	<b>49</b>
<b>9. HARDWARE SPECIFICATIONS .....</b>	<b>51</b>
<b>10. PACKAGE CONTENTS .....</b>	<b>52</b>
<b>11. WARRANTY .....</b>	<b>52</b>
<b>DECLARATION OF CONFORMITY .....</b>	<b>53</b>
<b>APPENDIX A – CONNECTORS .....</b>	<b>54</b>
<b>APPENDIX B – RFI Considerations .....</b>	<b>56</b>
<b>APPENDIX C – Tracking .....</b>	<b>57</b>

## 1 - FEATURES AND FUNCTIONS

### **General:**

- single USB connection to computer
- stand alone CW and FSK operation
- Complete "Computer <-> Radio" galvanic isolation
  - transformer isolation of sound card and radio
  - optical isolation of radio signals
- *Internal USB sound*
  - *Wide range audio level: works with transceiver levels from 100 mV to 1.5 V*
  - *Extremely low noise floor: as low as 0.7 mV effective*
  - *High dynamic range: 84 dB typical, 82 dB minimum*
  - *Supports Voice operation with microphone*
  - *Standard Windows Audio Class device – no custom driver required*
- compatible with most standard MS Windows based logging or control programs

### **Radio control:**

- integrated level converter for CI-V, FIF-232, IF-232, or RS-232
- up to 57600 Baud with handshake support
- supports most Elecraft, Icom, Kenwood, Ten-Tec, Yaesu and other radios
- SDR receiver tracking

### **Other:**

- Programmable LCD status display
- 2 Watt amplifier for monitor/sidetone
- CI-V output for controlling Icom compatible accessories
- Serial output for controlling generic peripherals
- user definable presets to recall all parameters for different control programs or contests
- all parameters stored in EEPROM and reloaded after power up
- integrated chokes and filters for maximum RFI immunity
- Metal/Aluminum case, powder coated and silk screened
- Free, no time limit firmware/software upgrades via Internet

### **Keying:**

- optical isolation of all keying signals from computer
- Hot Switch PA protection with user defined timing
- programmable PTT assertion delay in 1ms steps
- T/R sequencer with extended capabilities
- separately sequenced keying outputs for low noise amplifier or receive antenna control
- supports VOX and CAT T/R switching
- wide range solid state or relay PA and LNA PTT buffers

### **CW:**

- enhanced K1EL WinKey™ with paddle buffer
- front panel speed knob
- selectable side tone capabilities with "paddle side tone" function
- nine (9) user programmable memories
- application independent contest auto-numbering
- supports PS/2 keyboard for CW transmission with type ahead
- supports PS/2 keyboard or keypad for CW "memory keyer" and control
- PS/2 keyboard or keypad CW works without computer connection

**Voice (SSB/AM/FM):**

- front panel headset jacks
- rear panel hand/desktop microphone jack
- automatic microphone selection
- selectable preamplifiers allow electret and dynamic microphones in any combination
- Digital Voice Keyer with nine messages up to 120 seconds and unlimited “banks”

**Digital (FSK/AFSK/PSK31):**

- Dual channel receive capability
- transformers for DC isolation between radio and sound card
- low noise amplifiers for optimal decode level
- front panel level controls for each receiver
- front panel transmit level controls
- true FSK output
- supports data codes with 5/6/7/8 data bits and 1/1.5/2 stop bits
- unique, hot switch protected FSK keying
- separate PTT output for digital audio mode operation with microphone muting
- nine (9) user programmable memories (FSK)
- supports PS/2 keyboard FSK transmission with type ahead and diddle function
- supports PS/2 keyboard or keypad for FSK message playback and control
- PS/2 keyboard/keypad FSK works without computer connection

## 2 - IMPORTANT WARNINGS

**ALWAYS check the polarity of the 13.8 V power supply.**

**If you use *microKEYER II* with more than one transceiver, ALWAYS be sure the proper microphone is connected to the RJ45 jack BEFORE connecting the RADIO interface cable.**

**If your radio includes upgradeable firmware DO NOT perform any upgrade through *microKEYER II*.**

**Remember, under Windows, *microHAM USB Device Router* must be running anytime the interface is used (not just for setup). If Router is not running, the virtual COM ports will disappear and the device cannot be accessed!**

## 3 - PANEL DESCRIPTION

### Front Panel

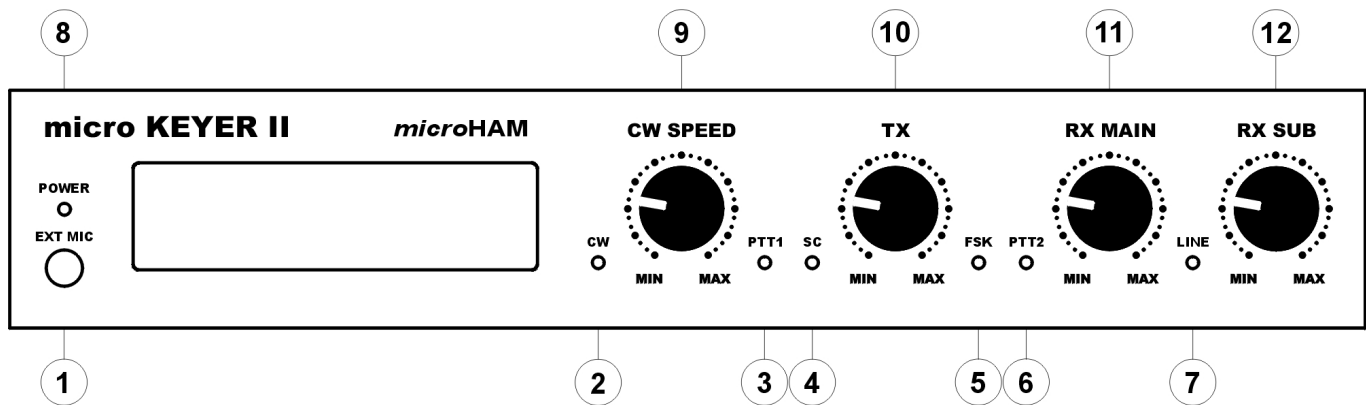

#### 1. EXT MIC

Connection for headset mic, e.g. Heil ProSet  
3.5 mm stereo - jumper select  
TIP - Dynamic Mic RING - Electret Mic/Bias SHELL – GND

#### 2. CW

LED flashes with CW output

#### 3. PTT1

LED lights when PTT1 (microphone connector) is active.

#### 4. SC

LED lights when the sound card is generating audio.

#### 5. FSK

LED flashes with FSK output.

#### 6. PTT

LED lights when PTT2 (transceiver accessory connector) is active.

#### 7. LINE

LED indicates "Line input" (receiver audio) is active

#### 8. POWER

LED lights when +13.8V is applied (power switch on).

#### 9. CW SPEED

WinKey speed control. Range (MIN, MAX) is defined by software

#### 10. TX

Sound card (DVK/Digital) audio level to transmitter.

#### 11. RX MAIN

Audio level from Main Receiver (left channel).

#### 12. RX SUB

Audio level from Sub Receiver (right channel).

## Rear Panel

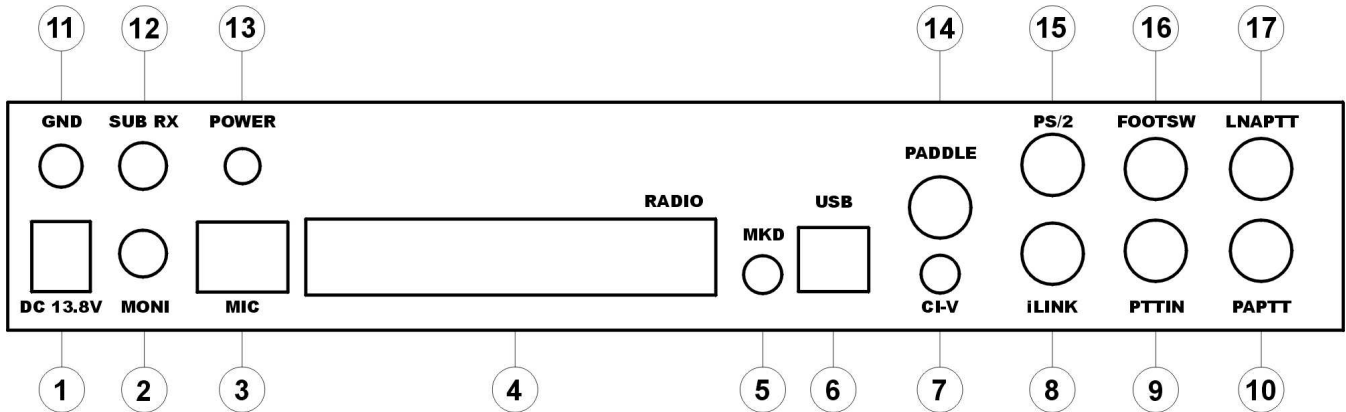

**1. DC 13.8V**

Power Supply - 2.1 x 5.5 mm coaxial jack, center is +

**IMPORTANT WARNING: Be sure to observe the proper polarity!**

**2. MONI**

Mono output for monitor speaker

Connector: 3.5mm TIP - Audio RING – no connection SLEEVE – Ground

**3. MIC**

Station microphone (original).

Connector: RJ45 female

**4. RADIO**

DB37F connector for radio interconnections.

See Appendix A for details

**5. MKD**

Not Used.

**6. USB**

USB B connector for computer connection.

Standard USB A-B cable.

**7. CI-V**

Auxiliary CI-V output for controlling external devices using Icom transceive protocol

Connector: 3.5mm TIP – signal RING – no connection SLEEVE – Ground

**8. iLINK**

MiniDIN-6 for external control applications.

**9. PTT IN**

Transceiver PTT Out (Send)

used for sensing when transceiver has been switched to transmit by VOX or CAT PTT.

Connector: RCA TIP – Signal SLEEVE – Ground

## 10. PA PTT

PTT output for Power Amplifier.

Output (**S**olid **S**tate or **R**elay contact) depends on RE/SS jumper position.

Connector: RCA, when active goes to ground.

TIP – Signal                      SHELL – Ground

If the jumper is in the SS position, the switching transistor (open collector) is connected to the PA PTT jack. The transistor can switch up to 45V/0.8A. This position is appropriate for modern Power Amplifiers with electronic keying. Check the manual of your amplifier to be sure the power requirements do not exceed the transistor rating. If the requirements exceed transistor rating set the jumper to the RE position - this position connects the relay contact to the output jack. Maximum rating for the relay is: 48V AC/DC @ 1A.

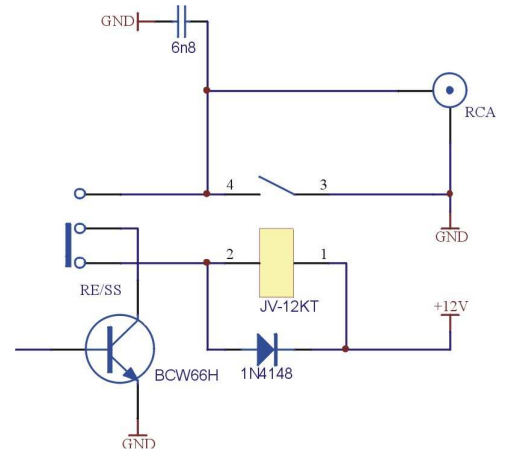

**TIP:** If you are not sure about the keying voltage of your Power Amplifier or LNA, use the RE position.



**TIP:** the RE/SS jumpers are located on the edge of the circuit board in front of the PA PTT and LNA PTT jacks.

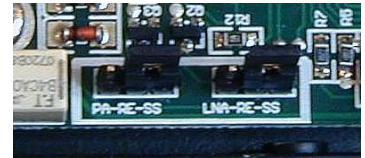

## 11. GND

Terminal for connection to station ground.

## 12. SUB RX

Audio input from transceiver (second receiver - right channel).

Connector: 3.5mm    TIP - Audio    RING – no connection    SLEEVE – Ground

## 13. POWER

Power Switch

## 14. PADDLE

6.3mm (1/4") stereo female for paddle input.

TIP - DIT    RING - DAH    SLEEVE – GND

**NOTE:** The paddle sense can be reversed using Router settings

## 15. PS/2

MiniDIN6 for PS/2 keyboard or PS/2 keypad.

## 16. FOOTSW

RCA foot switch input. Active when closed to ground.

TIP - Signal    SHELL – GND

## 17. LNA PTT

PTT output for controlling Low Noise Preamplifier or Receive antenna switching.

RCA jack TIP - Signal    SHELL - GND

See: 10 – PA PTT

## 4 - INSTALLATION

Installing *microKEYER II* consists of several steps:

- 1) prepare MK II to work with your radios
- 2) install microHAM USB Device Router (the control and interface software)
- 3) configure *microHAM CODEC*
- 4) configure Router
- 5) set audio levels

### Preparing *microKEYER II* for Use

1. Turn off the radio and make the rear panel of *microKEYER II* accessible.
2. Plug the DB37M of the radio cable set into the RADIO connector on the rear panel of the MK II. Connect ALL connectors from the cable set to the matching jacks on the rear panel of your transceiver.
3. If your transceiver has dual receivers (FT-1000D, FT-1000MP, FT-2000, FT-9000, Orion, IC-7800, K3, etc.) connect the fixed level audio output from the second receiver to the SUB RX jack
4. Connect the station microphone to the RJ45 MIC jack. If your microphone has a Foster (round) connector, use the adapter supplied with the cable set.
5. If the station microphone uses an electret element (most Icom radios), open *microKEYER II* and place the Electret jumper located just in front of the three trimmers in the center of the board on both pins.

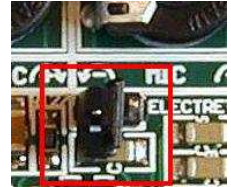

**WARNING:** Microphones with both dynamic and electret elements are not supported. Configure the MIC (RJ-45) input for either a dynamic or electret element and do not switch types.

6. If you use a second microphone, connect your headset to the EXT MIC jack on the front panel.

#### Serial Numbers less than 900:

If the headset microphone uses an electret element (e.g. Heil iC or typical computer headset), open the *microKEYER II* and move the DYN-EL jumper located behind the EXT MIC jack to the EL position.

**NOTE:** an electret element must be connected to both the tip and ring of the 3.5mm STEREO plug. Heil headsets will require a 3.5mm mono to stereo adapter.

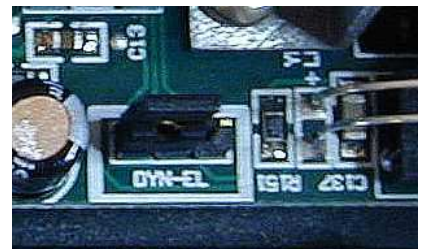

#### Serial Numbers greater than 900:

If the headset or boom microphone uses an Electret microphone with a STEREO plug (e.g. many computer headsets), open MK II and move the DYN-EL jumper located behind the EXT MIC jack to the EL position.

If the headset or boom microphone uses an electret mic with a MONO plug (e.g., Heil iC elements), open MK II and move the jumper to the iC position.

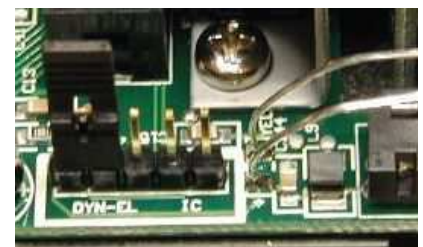

**WARNING:** Headsets with both dynamic and electret elements are not supported. Configure the EXT MIC for either dynamic or electret element and do not switch types.



7. Connect your paddles to the PADDLE jack.
8. For Icom transceivers, open MK II and install the ICVOX jumper located behind the PTT IN jack. Otherwise, connect your transceiver PTT Out (linear) to the PTT IN jack using the supplied RCA to RCA cable.
9. If you use a foot switch, connect the foot switch to the FOOTSW jack.
10. If your transceiver's accessory port is capable of supplying +13.8 V at 500 mA, you may install the DB37 Power jumper located in the right rear corner just in front of the +13.5 V DC jack.

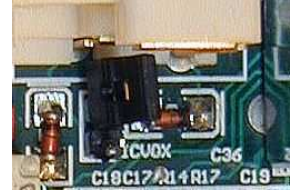

**NOTE:** Beginning with serial number 900, this header was converted to three positions. Connecting the left pair of terminals selects the 1.38V power jack while connecting the right pair of terminals selects power from the DB37 jack.

**WARNING:** DO NOT use DB37 Power input with Yaesu transceivers or if the Accessory power is less than 12 Volts when transmitting (Elecraft K3).

11. Connect a 12 to 16V DC supply to the DC 13.8V jack.  
**Be sure to observe the proper polarity!**

**NOTE:** DO NOT use the same power supply as the transceiver.

12. Locate but DO NOT connect the USB cable to the MK II at this time.

**NOTE:** If you will be installing on a Windows computer, skip to page 10.

## Mac OS X INSTALLATION

1. Insert the microHAM CD in your CDROM/DVD drive and navigate to Drivers/OS-X or use your web browser to go to <http://www.ftdichip.com/Drivers/VCP.htm> and download the latest driver image for OS-X.
2. Open FTDIUSBSerialDriver\_v2\_2\_14.dmg by clicking on it.
3. For OS-X 10.4, 10.5 or 10.6 open FTDIUSBSerialDriver\_10\_4\_10\_5\_10\_6 and follow the instructions to install.
4. Plug in the USB cable
5. Turn on the radio or external power supply.
6. Follow the instructions for your software to configure the application to work with microKEYER II.



**NOTE:** To access all the capabilities of *microKEYER II*, your OS-X software must be written to use the *microHAM Keyer Protocol* or  $\mu$ H Router by Kok Chen, W7AY.

## MICROSOFT WINDOWS (XP, Vista, Windows 7) INSTALLATION

### Installing *microHAM* USB Device Router



The Windows setup utility will start and ask into which folder Router and its supporting files should be installed. Note: unless you have a very strong reason to install Router elsewhere, please accept the default location.

When the Router installation is completed, click "Finish" to launch Router for the first time. Then plug in the USB cable and proceed to configuring Router for your station and software.

To install Router click on the Install USB Device Router link on the installation CD or download the most recent installation package from the web site: [www.microham.com/contents/en-us/d29.html](http://www.microham.com/contents/en-us/d29.html)

If you download an updated package, click on "urouter\_release\_xx\_xx.exe" (xx\_xx is version) to start the installation.



## Configuring *microHAM* CODEC

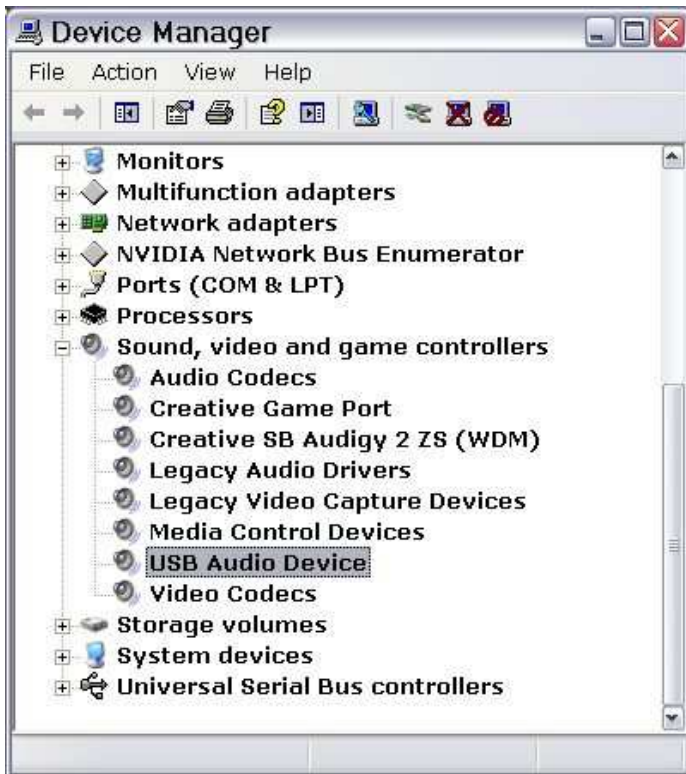

Windows will automatically install the USB Audio Device driver to support the *microHAM* CODEC in *microKEYER II*. Windows automatically activates any new audio device as the default device for Sound Playback and Sound recording.

This is undesirable as Windows Sounds would be played through *microKEYER II* and onto the air!



In Windows XP, open "Sounds and Audio Devices" in the Control Panel or right click on the Speaker icon on the Taskbar and select Adjust Audio Properties. Reset the Default device for Sound Playback and Sound Recording to your computer's primary sound device.



In Windows Vista and Windows 7, open "Sound" in the Control Panel or right click on the Speaker Icon on the Taskbar and select "Playback Devices." Reset the default to the Speakers of your computer's primary sound device.

## Configuring *microHAM* USB Device Router

The *microHAM* USB Device Router (Router) program provides a Windows compatible *configuration tool* for *microHAM* USB Devices (microKEYER II as well as DIGI KEYER, *microKEYER*, CW Keyer and USB Interfaces) and *software interface* to other Windows applications (logging software, digital mode software, etc.). The software interface is provided as *Virtual Serial Ports*.

In order to configure and use microKEYER II with Windows compatible application programs, you must be running Router and have turned on microKEYER II. Router is then configured as required by the application (logging, control or digital mode) software.

### *microKEYER* II Status

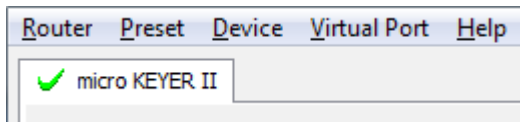

When the USB driver is installed correctly and *microKEYER* II is turned on Router will show a device tab with a **GREEN** check beside the device name.

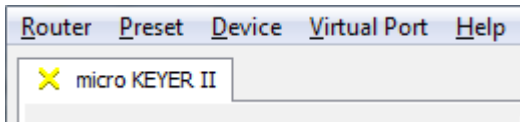

When Router shows a **YELLOW** "X" instead of a green ✓, it means the USB driver is correctly installed but *microKEYER* II is not turned on.

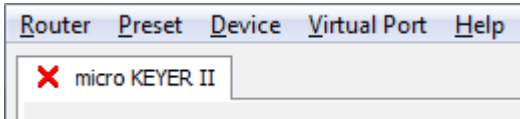

When Router shows a **RED** "X" instead of a green ✓, it means the device is disconnected and Router does not see the USB part of *microKEYER* II. This happens when the USB cable is unplugged or the USB driver is not correctly installed.

### Initial Setup

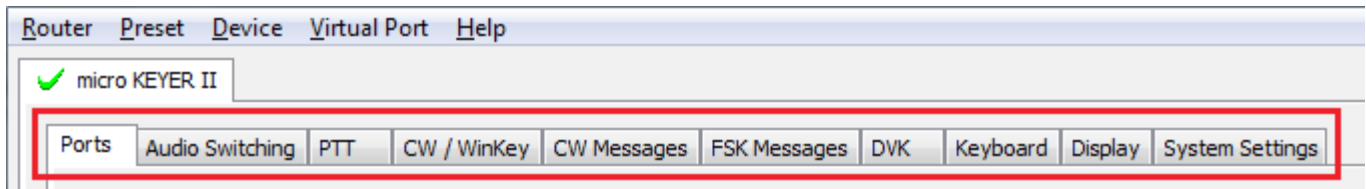

Router must be used to configure *microKEYER* II for proper operation. The device configuration tabs (in the red rectangle) are used to setup each part of the *microKEYER* II.

## Creating and Using Virtual Serial Ports

microHAM Router provides a set of virtual serial ports which allow Windows applications (logging and digital software) to work with microKEYER II just as they would work with "real" (hardware) serial ports.

In order to use these virtual Ports, you must first create the ports and then assign a port to each function you wish to use (radio control, PTT, CW, FSK, etc.).

**DO NOT** define a port that is already in use (for example, COM1 or COM2 which are hardware ports on many motherboards) or a virtual port that is used by another USB device. Even though Router will not allow creating a virtual port on a COM port number which is already present in the system (like hardware COM ports or internal modems), sometimes these ports are hidden. If another device that also uses virtual ports (external USB devices, bluetooth devices, mobile phones, PDAs etc.) is not connected when creating virtual ports in Router, the ports can overlap and will not work properly when you connect such device.

**WARNING:** Before you begin to create virtual ports, attach all external devices you are using with computer and allow them to be connected to the system. Restart Router and then create virtual ports.

Virtual ports are created and deleted from the Virtual Port menu.

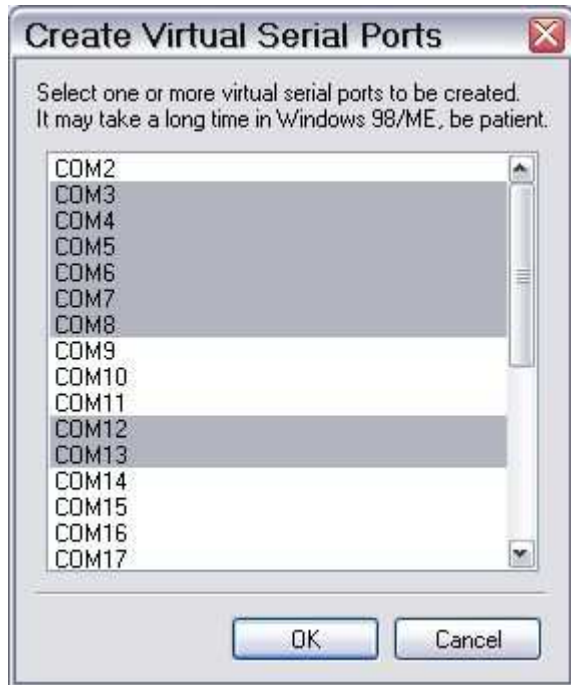

**Create** - Creates virtual COM ports. It is possible to select more than one port at a time by holding the *Ctrl* key on keyboard and clicking on COM port numbers. Creating virtual ports may take a long time (several tens of seconds), be patient.

**Delete** - Deletes any single virtual port.

**Delete All** - Deletes all previously created virtual ports.

Do not delete a virtual port until all applications using that port have been closed.



**TIP:** It is possible to select multiple ports at one time by holding the *Control* key on keyboard and clicking on the COM port numbers.



**TIP:** If you have removed another device which used virtual ports and Router does not offer the released port number, you will need to reset the virtual port bus. You can do this by deleting all virtual ports in Router at once. Select "Virtual Port | Delete All" then create the ports again. Any missing COM port numbers should appear.

## 5. microHAM USB DEVICE ROUTER

### ROUTER MENU

**Default Router Settings:** used to completely reset Router to factory (default) settings.

"Default" removes all device tabs and deletes all stored configuration data, including all user presets. from the Windows Registry.



**TIP:** *microKEYER II* can be reset to the factory configuration by selecting **Default Router Settings** followed by **Device | Store as Power-up Settings** to save the defaults to the keyer's memory.

**Restore Router Settings:** used to restore settings from a *urs* file created by the backup command.

A *urs* file can be used only with the device for which it was generated (the file contains the unit serial number) on a computer with same port assignments.

**WARNING:** Restoring a backup deletes all current Router settings including presets, **use it carefully!**

**Backup Router Settings:** used to create backup *urs* file.

This file contains Router settings (including Presets) for all devices defined in Router.

#### Options | General

**Load Router on Start-up:** when checked, Router will start automatically each time the computer is started or rebooted.

**Start Router Minimized:** when checked, Router will started minimized

#### Options | Band Map: **(Not used in *microKEYER II*)**

Customizable band edge boundaries used to drive the band data output.

**Options | Digital Band Map:** Customizable band limits for digital mode operation. This setting is used to automatically select VOICE or DIGITAL audio switching and the proper PTT output (PTT1/PTT2). The boundaries are necessary for transceivers which do not have a special mode for AFSK operation or do not provide this information via computer control. This primarily effects Kenwood and Ten-Tec transceivers although it is also applicable to some older Icom and Yaesu radios.

#### Options | Audio Devices:

**Don't use audio devices:** when checked, Router does not use audio devices and the settings on the Audio Mixer and DVK tabs have no effect.

**WARNING:** When selected, Router will not be able to control MKII Audio Mixer and DVK, **use it carefully!**

**Manually assign audio devices:** when checked, Router will allow the user to select audio devices (sound card) in the appropriate fields at Audio Mixer tab and will actively control the audio devices

**Automatically assign microHAM audio devices: **(Not used with *microKEYER II*)****

when checked, Router will automatically assign proper audio device of the same name if multiple microHAM interfaces of the same kind are connected to the one computer.

#### Options | DVK:

**Voice message time limit:** maximum time for each voice message up to 120 seconds.

**Sample rate:** sampling frequency used during recording and playback of voice messages.

**Sample size:** sampling size used during recording of voice messages. Sampling size primarily effects audio quality of the messages. 16bit samples provide higher quality than 8bit.

**NOTE:** Select the same sample rate and size as used by your software (logger) to avoid message distortion.

**Options | USB:**

**Noise immunity:** selects how many times an undelivered USB packet will be repeated before the USB device is disconnected from the operating system.

**Response time:** selects how long the USB interface will wait for additional data before sending data to the operating system.

**Minimize:** Clicking this will minimize Router to the system tray at the bottom right corner of the Windows Task Bar (the "System Notification Area").



**TIP:** When Router is minimized you can restore it by double-clicking on the Router tray icon. You can also restore Router by double-clicking on the Router icon on the desktop or in the Programs menu.

**Exit:** Clicking on this item will terminate Router.

**NOTE:** when Router is terminated the virtual ports will be closed and application software will be unable to communicate with microKEYER II and the radio.

**PRESET MENU**

The requirements of each application (logging, control and digital mode programs) are different. Each program handles radio control, CW, FSK, PTT, and the sound card its own way. In some cases, what works for one application may not work properly with another. To get maximum performance from *microKEYER II*, the user should create customized settings for each application used.

For easy switching among applications, Router supports up to 12 user definable **Presets**. Different configurations can be stored in these presets and recalled almost instantly simply by clicking on the preset button.

Each preset contains the settings for all devices connected to, and controlled by, Router. For example, if Router controls a *microKEYER II*, a USB Interface II and Station Master, each preset remembers the settings for all devices including the assignment of COM ports and the contents of all sub-tabs except the FSK/CW Messages and DVK tabs.

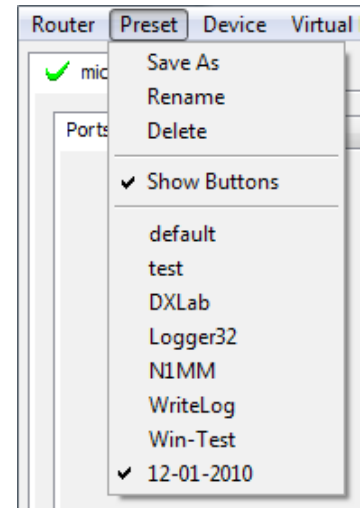

**NOTE:** Presets are not available until they have been created and saved by the user using **Preset | Save as**. For sample configurations for popular software, refer to the Setup Guide documents available in Router Help menu. Use **Help | Download Documents** if the Setup Guides are not available or incomplete.

There are three ways to apply a preset once it is created:

1. Click on **Preset** and select from the pull-down menu.
2. Click on a preset button. For the buttons to be visible in Router, **Preset | Show Buttons** must be checked. When the settings from a preset are applied, a green light located in the preset button is lit. This green light is on **ONLY** when all settings in Router are same as those stored in the preset.

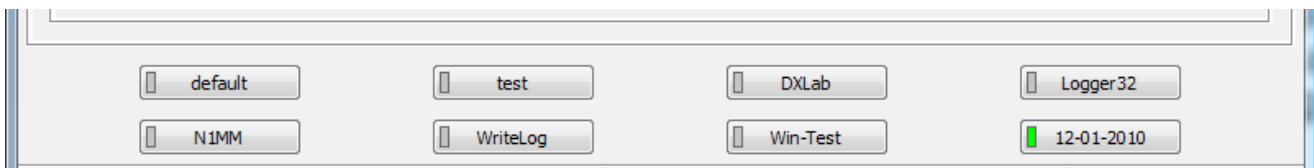

3. By right clicking on the system tray icon when the Router is minimized.
4. The presets and the current router configuration are stored to the registry when Router is closed and recalled when Router is loaded.

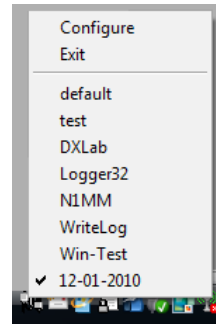

**Save as** - Saves the current Router settings to a preset for future use.

**Rename** - Allows renaming of an existing preset.

**Delete** - Delete chosen preset.

**Show buttons** - When checked, Router shows the preset buttons.

## DEVICE MENU

Router can control several devices. This allows configuring the settings for all (interfaces) connected to the computer at the same time using the Presets.

Each device has its own tab (page) in the main Router notebook. The content of each device tab depends on the type of device. Adding a device is automatic when Router detects a new device. Once detected, a device remains in Router even though device is disconnected. Each device is identified by a unique serial string.

**NOTE:** Router supports all microHAM USB devices in a single instance by creating a separate root tab for each device. It is not necessary to run multiple instances of Router; a secondary instance can not be started.

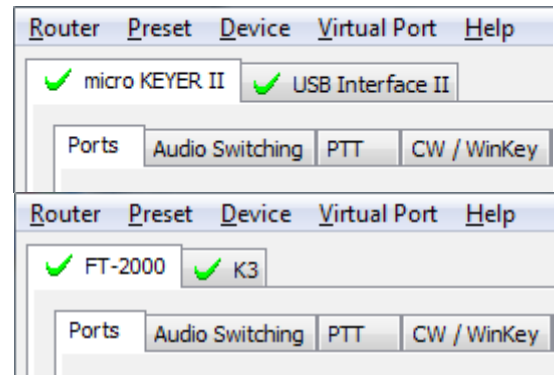

**Rename** – Creates a custom device name. This is useful if two or more devices are connected to the Router. For example *microKEYER II* and *USB Interface II* can be renamed to more identifiable names as shown here...

**Delete** - Removes a device from the Router. Only devices that have been disconnected (those with a **RED "X"** on device tab) can be removed. To disconnect a device from Router, unplug the USB cable.

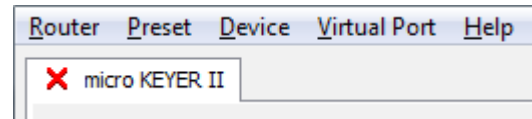

**Save Template** - will save the current Router settings to template file.

When clicked, Router will open a standard File Save dialog window – the default location is *C:\Documents and Settings\All Users\Application Data\microHAM\cfg*. If a hypertext (*html*) or plain text (*txt*) documentation file of the same name as the template is present in the same directory, it will be associated with the template.

**Load Template** – will automatically configure Router from a template (*\*.tpl* file).

When clicked, Router will open a standard File dialog – the default location is: *C:\Documents and Settings\All Users\Application Data\microHAM\cfg* - and the desired template can be chosen. When Router loads a template, it looks for an *html* or *txt* file with the same name as the template in the same directory. If such file is found, it is displayed.



**TIP:** Templates are a powerful tool for quickly configuring Router to work with a particular application. Template files are interchangeable between computers and ideal for cloning setups in multi-computer stations or for sharing configurations between users.



**Store as Power-Up Settings:** - will store the current settings of the Audio Switching, PTT, CW/WinKey, Keyboard, Display and System tabs to the microKEYER II EEPROM. If microKEYER II is operated without connection to the computer it will use the settings stored in EEPROM. If microKEYER II is connected to a computer running Router, the Router settings will be used but the default settings are retained in EEPROM.

**Upload Firmware:** microHAM will occasionally release updates to the firmware in microKEYER II. The update may support new features in Router or improve application compatibility. The most recent public version of the firmware is always available from [www.microham.com/contents/en-us/d29.html](http://www.microham.com/contents/en-us/d29.html)

To update firmware, download the firmware file to your computer, then click on **Device | Upload Firmware**. A Windows file dialog will open, navigate to the directory into which you downloaded the firmware file and select the file.

**NOTE:** When upgrading Router, the upgrade will include the latest firmware for *microKEYER II*. If the firmware is newer than the currently installed firmware, Router will automatically ask for permission to update the installed firmware the first time it connects to *microKEYER II*

## VIRTUAL PORT MENU

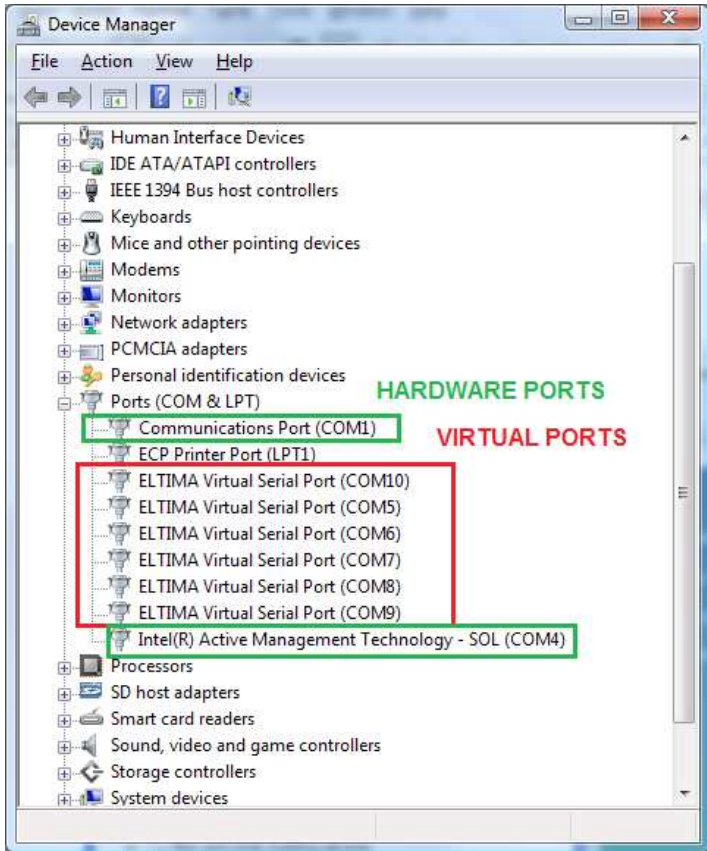

It is necessary to create a number of virtual serial ports (COM ports) in order for a Windows application (logging, control or digital mode program) to access *microHAM* devices.



**Create** - Creates virtual COM ports. It is possible to select more ports at once by holding the *Control* key on the keyboard and clicking on COM port numbers. Creating a virtual port may take a while, be patient.

**Delete** - Deletes any single virtual port.

**Delete All** - Deletes all previously created virtual ports and resets Virtual Serial Port bus.

Do not delete a virtual port unless all applications using that port have been closed.

**NOTE:** Properly working ports should not display an exclamation mark (!).

## HELP MENU

**Manuals:** Link to *microHAM* manuals located on your system.

**Setup Guides:** Link to software configuration guides for many common applications.

**Cable Schematics:** Link to cable diagrams.

**Download Documents:** Downloads *microHAM* documentation including updated manuals and setup guides. You may specify the products for which you want documentation.

**NOTE:** Requires an Internet connection.

**microHAM Home Page:** Link to [www.microHAM.com](http://www.microHAM.com)

**microHAM Downloads Page:** Link to [www.microham.com/contents/en-us/d29.html](http://www.microham.com/contents/en-us/d29.html)

**Show Tooltips:** When checked, small, single line help is displayed below the mouse cursor.

**Update Router:** Download and install the most recent version of Router.

**About:** Shows the Router's internal version number

**Change logs:** Shows the Router and firmware changes.

## DEVICE CONFIGURATION TABS

There are eleven (11) tabs for configuring microKEYER II. Each tab controls part of microKEYER II's functions. Except for CW Messages and FSK Messages, any change is applied immediately.

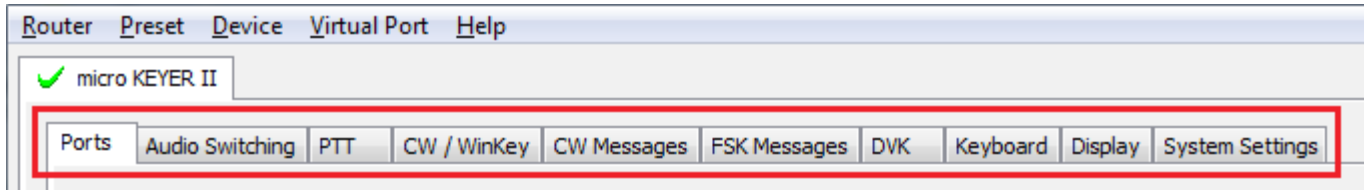

- **Ports:** assign virtual ports to the microKEYER II for use by applications
- **Audio Switching:** configures microphone audio routing based on operator preference, application sound card handling and operating mode
- **Audio Mixer:** sets *microHAM* CODEC levels.

**NOTE:** The Audio Mixer is not available under Windows Vista or 7. Those operating systems do not allow an application like Router overall control of the sound device.

- **PTT:** configures T/R keying, keying sequencer and foot switch functions
- **CW/WinKey:** configures the internal CW keyer
- **CW Messages:** enter/store internal CW message memories
- **FSK Messages:** enter/store internal FSK message memories
- **DVK:** configure and control the level of Router's voice keyer
- **Keyboard:** configure operation of PS/2 keyboard or keypad
- **Display:** configures operation of the LCD display.
- **System Settings:** configures power control and operation of the auxiliary CI-V/serial ports

## PORTS TAB

Once the virtual ports have been created they must be associated with a specific function or device channel (e.g., Control, CW, PTT, etc.). These assignments should correspond to settings of the application software and must be configured first in Router then in the application.



**Correct port assignment is critical for proper operation with application software.**

microKEYER II has 11 channels – each channel provides an indication of the settings applied by the application and current state (e.g., on or off):

- **CAT** (uses RxD and TxD)
- **2<sup>nd</sup> CAT** (virtual “fork” for the main CAT channel)
- **FSK** (uses TxD for FSK and RTS for PTT if checked)
- **2<sup>nd</sup> FSK** (uses TxD for FSK and RTS for PTT if checked)
- **CW** (uses DTR or RTS)
- **PTT** (uses DTR or RTS)
- **2<sup>nd</sup> PTT** (uses DTR or RTS)
- **Foot Switch** (uses CTS, DCD, DSR or RING)
- **Auxiliary** (uses RxD and TxD)
- **WinKey** (uses RxD and TxD)
- **Control** (uses RxD and TxD)

**NOTE:** Do not assign virtual ports to the channels/functions which are not used by your applications. It is unnecessary and only consumes resources.

## CAT PORT & 2<sup>nd</sup> CAT PORT

The CAT channel is used by the application software to control transceiver frequency, mode, T/R switching and many other parameters. The application communicates with the radio using a serial protocol. Although most modern radios implement some form of serial control, nearly every radio implementation is different. The degree of control available for each radio depends on that radio and the application (logger or digital program).

**NOTE:** The COM port number assigned in Router **MUST** match the port number assigned in the host application. First configure the virtual COM ports in Router then configure the application.

When a COM port is assigned in the Router but not in the application (or the application is not running) Router will indicate the channel is **closed**.



When an application opens the COM port assigned for control (usually at start-up), Router shows the channel as **open** and displays baud rate, data bits, parity and number of stop bits used by the application. For example, 4800 8N2 means: 4800 baud, 8 bits data length, parity = none, and two stop bits.

Data flowing through the CAT channel is indicated by two arrows. A green arrow indicates data flow from the host application to the radio and a red arrow indicates data flow from the radio to the application.



**TIP:** If the application provides for PTT (T/R) keying by radio control (CAT) turn this function OFF. PTT by CAT is not reliable because RFI can prevent the radio from switching back to receive. There is a dedicated T/R switching channel for this purpose called PTT.

**NOTE:** If your radio does not support handshake (most do not). Configure DTR and RTS settings in your application program (logger) for Always On or Always Off. Do not select "Handshake."

For Router to determine the operating frequency and mode, it must know what radio (CAT protocol) being used. To select the radio, click the **Set** button, choose your radio in the **Radio** combo box, select communication speed in the **Baud rate** box, and set the CI-V address for Icom and some TenTec radios.

When the radio is communicating with Router, click **Device | Store as Power-up Setting**. This will save the radio type to the EEPROM and allow frequency decoding/iLink updates even if Router is not running (stand-alone mode).



**TIP:** Disable **AUTOBAUD** in Icom transceivers. Set the radio, Router, and application software to operate at 9600 or 19200 baud.

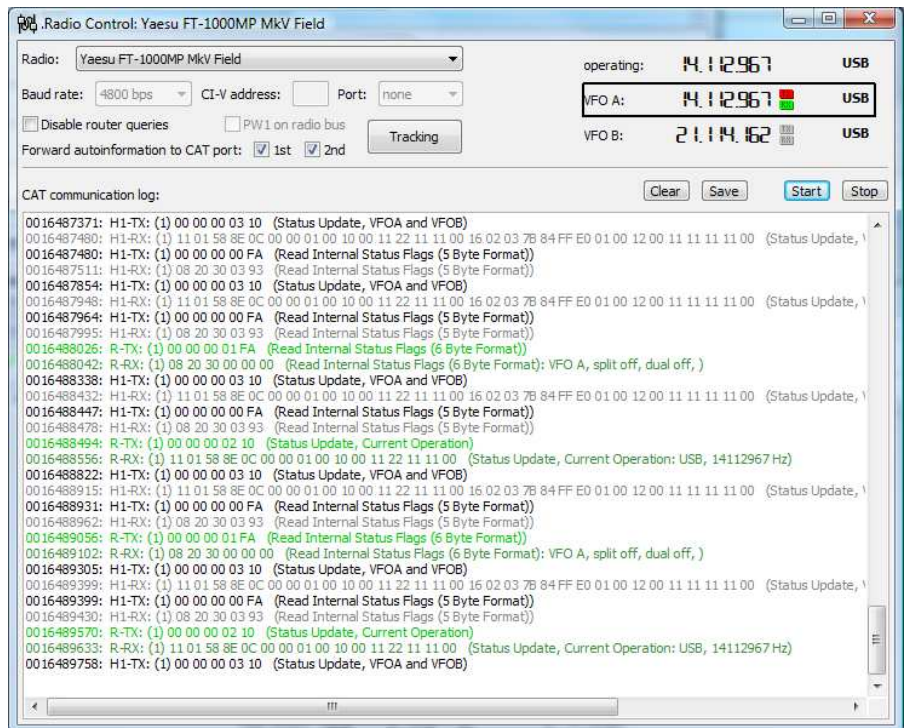

**NOTE:** The baud rate must match your radio. Icom and some TenTec radios require the correct **CI-V address**. If everything is configured properly, your radio's current operating frequency and mode should be displayed.

**Disable router queries** – When this box checked, Router will not poll the radio for frequency and mode when that information is not available from the communication between the application and radio.

**NOTE:** "Disable router queries" disables Router polling only when the port has been opened by an application program. When the virtual port is closed, Router always polls the radio to support the automatic switching functions of *microKEYER*. If it is necessary to disable all polling, select one of the "none" options in the Radio box.

**WARNING: DO NOT select "Disable Router queries"** unless you have a specific reason to do so. Router only polls for information that is not requested by the logger and does not interfere with logger polling. Disabling Router queries may result in incorrect frequency and/or mode decoding and can have a serious impact on overall operation.

**PW1 on radio bus** – When this box checked, Router periodically generates an Icom "Transceive" broadcast to keep the PW1 synchronized.

**NOTE:** Check this box if you have an IC-PW1 or other Icom compatible accessory physically connected (in parallel with the transceiver). Do not check this box if the only connection is to the transceiver and the PW1 or other other accessory is connected to the accessory CI-V PA port (described later).

**Forward autoinformation to CAT port:** When checked, all unsolicited packets (Icom "transceive" packets or "Auto-information" data from Kenwood, Elecraft and recent Yaesu transceivers), coming from the radio are transferred to the CAT port. Each CAT port has own check box.

**Port:** Defines a virtual or hardware serial port for an SDR radio used with the MKII. The CAT connection in *microKEYER II* is disabled. **This function is not currently supported.**

### **SDR Tracking:**

**Tracking:** This function allows an external receiver to track the transceiver attached to the *microKEYER II*.

**NOTE:** The transceiver attached to *microKEYER II* must be properly interfaced and CAT must be functioning properly. Tracking does not work for "no radio" choices.

**Radio:** Specifies SDR receiver model.

**Source QRG:** Specifies whether the SDR will track the transceiver transmit or receive frequency. .

**Port:** Specifies COM port used to communicate with the SDR.

**Offset:** Frequency offset between the receiver and transceiver. Default is 0Hz, resolution is 1Hz.

**NOTE:** For specific receiver configurations, please refer to Appendix . .

The bottom two-thirds of the **Radio** window is a CAT communication monitor. The monitor uses colors and tags to indicate which device is responsible for the data. Black queries (H1-TX or H2-TX) and gray radio responses (H1-RX or H2-TX) are from the "host" application (e.g., logger), H1 indicates the host application on the main CAT port, H2 is the host application on the 2<sup>nd</sup> CAT port. Green packets (R-TX and R-RX) are polls/responses from/to Router and not routed to the application.

Router monitors the communication when the host application performs control and polls the radio periodically for any missing information (VFO frequencies and mode). Because some applications do not poll the radio regularly or completely, Router must break this communication to update its internal state. In order to avoid confusing the application when Router polls the radio, data from the application is buffered and sent to the radio after Router receives a response to its query. If Router does not receive response to a poll within the time allowed or does not understand the response, it displays "oldest query discarded" but forwards all data to the virtual serial port to avoid confusing the application (logger).

USB transmits data in frames with a delay between frames, Router indicates frame boundaries with three dots (...). When a packet ends with three dots it means that the data continues in the next frame.

**IMPORTANT:** For *microKEYER II* to operate properly when Router is not running, the settings must be saved as power-up defaults using “Device | Store as Power-Up Settings.”

## 2<sup>nd</sup> CAT PORT

Beginning with version 7.0, Router provides a unique control capability: the 2<sup>nd</sup> CAT Port is an intelligent data fork (software 'Y' connector) that allows a second application to share control of the radio. Router monitors when data is sent from each application and routes the radio's responses to the correct virtual port.

**IMPORTANT:** Both applications must use same communication parameters (baud rate, data length, parity and number of stop bits) for proper operation!

Neither CAT port has priority. Polls/commands from each application are processed alternately. In order to avoid collisions and avoid confusion due to unexpected data, responses from the radio are returned only to the application that generated the command. Unsolicited data from the radio such as automatic frequency/mode updates (Icom "transceive" packets or "Auto-information" data from Kenwood, Elecraft and recent Yaesu transceivers) can be forwarded to both CAT ports individually when appropriate “Forward autoinformation to CAT port” box is checked.

Due to limitations in the data channel throughput in the radio and the controller capabilities in various transceivers, there are several important rules which must be observed.

- Total data throughput from both applications must not exceed maximum response rate of the transceiver. In other words, the polling rate from one application may need to be decreased to provide data space for the second application and vice versa.
- Applications must be tolerant of response delays. Each logger must be able to wait for a response while the other logger communicates with the radio.
- Due to protocol deficiencies in handling VFO split commands with many transceivers (particularly Icom), split mode must be initiated and ended by only one application and manual split control (from the front panel of the radio) should not be used.

**NOTE:** Although Router has been tested extensively using many different applications on the CAT and 2<sup>nd</sup> CAT ports, *microHAM* cannot guarantee proper operation with every possible combination of software.

## FSK & 2<sup>nd</sup> FSK PORTS

The FSK channels are used by application programs to send the FSK keying signal. FSK is used primarily for RTTY. It is very important to understand the difference between FSK and AFSK.

**FSK** is a digital (On/Off) signal used in the transceiver to generate a frequency shift. FSK must be supported by the transceiver (this mode is commonly labeled RTTY or FSK).

**AFSK** is an analog (audio) signal used to modulate the transceiver for digital modes like RTTY, PSK31, AMTOR etc. Computer sound card generated AFSK or PSK does not require special transceiver support and can be used in the LSB, USB or FM mode of the transceiver. Some radios have dedicated modes for AFSK (generally labeled PKT, DATA, LSB-D or USB-D) with special features.

*It is very important to properly adjust the audio drive level of an AFSK system so as to not overdrive the first transmit audio amplifier stage in the transceiver and produce a wide, distorted signal, full of intermodulation products. It is important to appreciate that distortion generated at this point due to overdrive CANNOT be reduced or eliminated by the reduction of the microphone gain control – it is the signal level that must be adjusted to be about the same as would be expected from a microphone. The microphone gain control then becomes a form of transmit power control.*

*An initial indication of proper audio drive level can be seen on the ALC meter of the radio. Provided that there is NO audio processing in circuit and that the microphone gain control is in its normal operating position, then, if the ALC does not show or just starts to indicate during transmission, the signal is likely to be clean. It is also important is to turn off the microphone compressor, ANY transmit audio equalizer, AND transmit DSP when AFSK is used. DO NOT use any form of digital modulation (sometimes called "Transmit DSP") with AFSK or PSK. Some transceivers bypass these circuits automatically when signal is routed to the rear audio jack instead of the microphone jack, but some do not (for example, the TS-850).*

*Edited by Geoff Anderson, G3NPA*

**If your transceiver supports FSK, use FSK for RTTY whenever possible. It's the only sure way to get a clean RTTY signal no matter the microphone gain or compressor (processor) settings on your radio.**

When a COM port is assigned in Router but not in the application program (or the application is not running), Router will indicate the channel is **closed**.

When an application opens the COM port, Router will indicate the channel is **open** and display baud rate, number of data bits, parity and number of stop bits in use. For example, 45 5N1.5 means: 45 Baud, 5 data bits, no parity, and 1.5 stop bits.

FSK:	COM6	<input checked="" type="checkbox"/> PTT	45 5N1.5	<input type="button" value="Test"/>
2nd FSK:	COM7	<input checked="" type="checkbox"/> PTT	closed	<input type="checkbox"/> invert <input type="checkbox"/> strict bps

The 2<sup>nd</sup> FSK port is useful when operating split with radios that have two receivers (e.g., FT-1000, FT-2000, FT-9000, K3, Orion or IC-7800). The second instance of the RTTY program should specify "right channel" for its audio source and should be configured to use the 2<sup>nd</sup> FSK port for its FSK output.

Radios without a second receiver can use the 2<sup>nd</sup> FSK port for a second RTTY program with a different decoding algorithm to provide diversity decoding and permit transmitting from either program.



**TIP:** If you see a baud rate other than 45.5 baud (e.g., 4800 or 9600), the application is NOT configured correctly for FSK RTTY operation.

**PTT:** The virtual port used for FSK can also support PTT (required by MMTTY). When you use MMTTY, select the PTT box and RTS will be used for PTT. Do not use the FSK port for any other purpose.

**Invert:** Some transceivers lack the ability to set the sense of the FSK input. If you cannot set the proper sense, check the invert box. This is normally necessary only with the TenTec Omni V, Omni VI and Kenwood TS-940.



**Strict bps:** Some programs rely on the the UART "buffer full" signal for proper PTT timing and drop PTT (unkey) when the UART buffer is empty. Because virtual ports generally have two buffers - one in the USB driver and one in the hardware - the first buffer may empty before all of the data has been transmitted allowing the PTT to before the message is complete. 'Strict bps' disables the USB buffering and sends one character at a time to the FSK output. With "Strict BPS" selected, the output will be about 20% slower due to the presence of extra stop bits between characters but proper PTT operation will be assured.

**NOTE:** DO NOT select Strict bps for MMTTY, USB option C provides accurate timing.

To test FSK operation from the computer to the radio, click on **Test** button with no port assigned or the port closed. The Test button will generate "RY" two times.

## CW PORT

By its very nature, USB is not well suited to transfer the real time events required for CW keying. In addition to the latency inherent in the USB protocols, there are also latencies caused by computer CPU load, internal Windows message processing (inter-process communication) and data flow from another peripherals sharing same the USB hub. This can result in transmitted characters that are garbled. To minimize these unwanted operating system effects Router uses a specially developed oversampling and prediction algorithm to assure the smoothest possible transfer of control signal events over USB. Using this principle, CW keying in the Router is, in most cases, usable up to 50 WPM if the application generates keying signals accurately and does not consume 100% of CPU time at the highest priority class.

Router allows assigning a virtual serial port for software CW using DTR or RTS signals. The DTR\* and RTS\* are identical to DTR/RTS except that the output is inhibited for one second after the COM port is opened. RTS\*/DTR\* should only be used with programs that cause unwanted key-ups during startup.



**TIP:** More applications use DTR for CW than RTS.

When an application opens the COM port (usually at start-up), Router will indicate the channel is **open**.

The state of the CW channel is indicated by a red arrow. If port is opened, it does not mean that it is properly configured. The red arrow will light in time with the transmitted CW when the port is properly configured.



To test CW operation, click on the **Test** button with no port assigned or the port closed

## PTT & 2<sup>nd</sup> PTT PORTS

The PTT channels are used to control transmit/receive switching of the transceiver and power amplifier. An internal sequencer assures 100% protection against hot switching of the PA when the PTT channel is used. More information about T/R switching and the sequencer is provided under the PTT tab.

Router allows assigning virtual serial ports for PTT using the DTR or RTS signals. DTR\* and RTS\* are identical to DTR/RTS except that the output is inhibited for one second after the COM port is opened and should only be used with programs that cause unwanted key-ups during startup.



**TIP:** More applications use RTS for PTT than DTR.

The state of the PTT channel is indicated by a green arrow. If the port is opened, it does not mean it is properly configured. When the port is properly configured, the arrow will light during the entire transmission. To test PTT operation, click on the **Test** button with no port assigned or the port closed.

The screenshot shows a configuration panel with two rows. The first row is labeled 'PTT:' and has a dropdown menu set to 'none', another dropdown menu set to 'RTS', and a right-pointing arrow. The second row is labeled '2nd PTT:' and has a dropdown menu set to 'none', another dropdown menu set to 'RTS', and a right-pointing arrow. To the right of these rows is a button labeled 'Test'.

The 2<sup>nd</sup> PTT channel is identical to the primary PTT channel. 2<sup>nd</sup> PTT provides a way for a second application to key the radio if the primary application also controls PTT – for example, a logging program and CW reader/keyboard.

To test PTT, click on the **Test** button with no port assigned or the port closed.

**NOTE:** The test buttons do not activate PTT in voice modes.

## FOOT SWITCH

Even though many applications do not monitor the status of the foot switch and do not have the ability to perform specific functions base on closing or releasing the foot switch, we have decided to implement this feature in Router. Hopefully sometime soon applications will be able to detect the foot switch status and use this this information for automating user functions like in the DOS based TRLog.

Router allows assigning a virtual serial port to the foot switch channel and selecting one of four available input control lines (CTS, DCD, DSR or RING).

**NOTE:** CTS is not available if the foot switch channel is shared with the radio control port. The state of the signal on the virtual port can be inverted by checking **inverted** box.

When a COM port is assigned for the foot switch but the application does not support foot switch status (or no application is running), Router reports the channel as **closed**.

When an application opens the COM port (usually at start-up), Router reports channel as **open**.

The screenshot shows a configuration panel for the foot switch. It includes a label 'Foot Switch:' followed by a dropdown menu set to 'COM4', another dropdown menu set to 'CTS', a checkbox labeled 'inverted' which is currently unchecked, and the text 'open' with a red arrow pointing to the right.

When the foot switch is pressed, this state is indicated by a red arrow.

## WinKey PORT

WinKey is a unique external CW processor developed by Steve Elliot, K1EL. This CW processor supports paddle input like any other electronic keyer, offers many configuration options, and in addition converts ASCII data from the computer to Morse characters. This unique property assures perfectly timed CW output from the computer regardless of OS load. More detailed instruction for configuring WinKey is found in the description of the CW/WinKey tab.

When a COM port is assigned to WinKey in Router but not in the application program (or no application is running), Router reports the port **closed**. When an application opens WinKey, (usually at start-up), Router shows the port **open** and displays settings used to configure COM port.

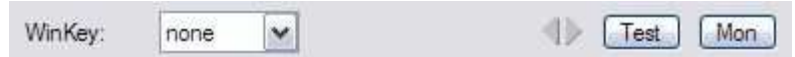

**TIP:** If you see settings other than 1200 8N2, the application is not configured correctly for WinKey. If the data rate is incorrect, Router will transfer data to WinKey at 1200 baud. However, reliable operation is not guaranteed.

Data flow is indicated by two arrows. The green arrow indicates data flow from the application to WinKey and the red arrow indicates data flow from WinKey to the host application.

**Test:** Sends "Test" via WinKey when the channel unassigned or closed.

**Mon:** "WinKey Monitor" allows capturing communications between Router or the application and WinKey. Controls for the monitor include **Start**, **Stop**, **Clear** and **Save**.

WinKey Monitor should not be used under normal conditions. However, if there are problems with WinKey and a logger, it may be useful to **Start** a capture and close the window. When a problem is noticed, the window can be opened and the WK communications log **Saved** for analysis.

WinKey Monitor is circular – only the last 20 kilobytes or so will be saved in order to prevent creating very large files.

```

microKEYER.WinKey Monitor
WK communication log:
0028701703: Log enabled. (router v5.0.0)
0028708271: Port opened
0028708271: H-TX: 00(-) 04(00 04) 57 [Admin: EchoTest. 0x57]
0028708271: H-TX: 00(-) 04(00 04) 57 [Admin: EchoTest. 0x57]
0028708333: H-RX: 57 W
0028708349: H-TX: 00(-) 02(00 02) [Admin: HostOpen]
0028708349: H-RX: 57 W
0028708380: H-TX: 0A 15 05 0A 1E FF 04 01 0A(01) 10 00 11 00 17 32 12 32 0D 0F(12) 0E 04(44) 01 05(00) 02 00 07 [Clear Buffer]
0028708380: H-RX: 0A
0028708395: H-RX: C0 [status: WAIT=0, KEYDOWN=0, BUSY=0, BREAKIN=0, XOFF=0]
0028708645: H-RX: 80 [speed: min=0=10WPM]
0028709815: H-TX: 15 [Request WinKey Status]
0028709831: H-RX: C0 [status: WAIT=0, KEYDOWN=0, BUSY=0, BREAKIN=0, XOFF=0]
0028711360: H-TX: 15 [Request WinKey Status]
0028711375: H-RX: C0 [status: WAIT=0, KEYDOWN=0, BUSY=0, BREAKIN=0, XOFF=0]
0028712046: H-TX: 09 04(05) [Set Pin Config: Pin5PTT=0(1), Pin5SideTone=0, Pin3KeyOut=1, Pin5KeyOut=0, HangTime=1.0wordsp
0028712046: H-TX: 02 00 [Set WPM Speed: speed pot]
0028712046: H-TX: 07 15 [Get Speed Pot] [Request WinKey Status]
0028712124: H-RX: 80 C0 [speed: min=0=10WPM] [status: WAIT=0, KEYDOWN=0, BUSY=0, BREAKIN=0, XOFF=0]
0028712140: H-TX: 57 W
0028712140: H-TX: 34 4
0028712171: H-RX: C4 [status: WAIT=0, KEYDOWN=0, BUSY=1, BREAKIN=0, XOFF=0]
0028712186: H-TX: 54 T
0028712826: H-RX: 57 W
0028712842: H-TX: 56 V
0028713902: H-TX: 15 [Request WinKey Status]
0028713918: H-RX: C4 [status: WAIT=0, KEYDOWN=0, BUSY=1, BREAKIN=0, XOFF=0]
0028713934: H-TX: 20
    
```

WK Monitor will display a description of each command from Router or the application and "decoded" response from WinKey. " If a line ends in three dots (...) it means that the command or response has been broken across two USB packets.

## AUXILIARY PORT

The Auxiliary Port allows an application program (logger) to control an auxiliary device attached to the iLink port. The Auxiliary port implements serial in and serial out (RxD and TxD) as TTL signals – interfacing to an RS-232 device will require a TTL to RS-232 converter, for example the *microHAM* iLINK/SteppiR.

When an application opens the Auxiliary port, Router reports port as **open** and displays settings used to configure COM port.

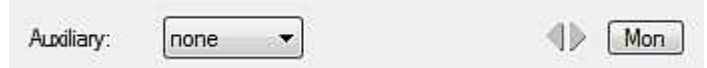

Data flowing through the channel are indicated by two arrows. The green arrow indicates data flow from the application and a red arrow indicates data to the host application.

**Mon:** Opens an “Auxiliary Serial Port Monitor” window to capture data between the application and auxiliary device. Controls for the monitor include **Start, Stop, Clear** and **Save**.

The Auxiliary Serial Port Monitor should not be used under normal conditions. However, for debugging purposes, it may be useful to **Start** a capture and close the window. When a problem occurs, the window can be opened and the Serial Port log **Saved** for analysis.

The monitor log is circular – only the last 20 kilobytes or so will be saved in order to prevent creating very large files.

If a line ends in three dots (...) it means that the command or response has been broken across two USB packets.

## CONTROL PORT

The Control Port allows an application program (logger) that implements the microHAM Control Protocol to make use of the microKEYER II CW, FSK and DVK message memories

When an application opens the control port, Router reports port as **open** and displays settings used to configure COM port.

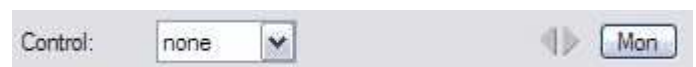

Data flowing through the channel are indicated by two arrows. The green arrow indicates data flow from the application and a red arrow indicates data to the host application.

**Mon:** Opens a “Control Protocol Monitor” window to capture microHAM Protocol communications between a logger and Router. Controls for the monitor include **Start, Stop, Clear** and **Save**.

The Control Protocol Monitor should not be used under normal conditions. However, if there are problems between a logger and Router, it may be useful to **Start** a capture and close the window. When a problem is noticed, the window can be opened and the Control protocol log **Saved** for analysis.

The monitor log is circular – only the last 20 kilobytes or so will be saved in order to prevent creating very large files.

The monitor will display a description of each command from the application and the response from Router. If a line ends in three dots (...) it means that the command or response has been broken across two USB packets.

## AUDIO SWITCHING TAB

microKEYER II uses an advanced, custom USB audio subsystem which allows Router to handle all of the audio routing. Microphone and receive audio are always connected to *microHAM* CODEC (the *microKEYER II* “sound card”).

On transmit, the selected microphone or sound card output will automatically be connected to the transmitter's microphone or line (rear panel) input based on the mode, and optionally frequency, reported by the transceiver in response to polling by the application (logger) and/or Router. If Router is not able to read the operating mode from your radio (radio does not have computer control port or does not report usable mode information), you can select one of four fixed “no radio” modes or one “no radio” mode with manual (keyboard/keypad) mode selection.

*Many radios fail to provide a separate mode for digital operation or the serial control protocol implemented by the radio does not report the digital mode when operating AFSK, PSK or other audio based digital modes. This is true for all Kenwood transceivers, most Ten-Tec transceivers, most older Icom transceivers and the Elecraft K2. With those radios, digital operation (except for FSK) must be done using voice modes (USB or LSB).*

*The traditional method – feed the microphone jack from the sound card output through a transformer – is not optimum for many reasons: you need to remember to turn off any speech compressor and EDSP or other signal processing when using digital modulation operating using in digital modes. In addition, the microphone amplifier in the radio can cause distortion because it is optimized for voice and its frequency response is often not as flat as necessary for digital modulating signals.*

*The proper method is to feed sound card audio to the microphone jack only for voice modes (SSB, AM, FM) and to the jack designed for digital modes - generally on the transceiver's rear panel – when using sound card based digital modes.*

Even though the radio may not report a unique DIGITAL mode, Router can make an intelligent choice and apply the DIGITAL or VOICE configuration for Audio and PTT based on the operating frequency from the radio. The **VOICE/DIGITAL settings selector** is used to control automatic switching when the operating frequency is in the “Digital Band” as defined in the **Digital Band Map** and the transceiver is in USB, LSB or FM mode.



**Select by frequency:** Router will select DIGITAL settings when detecting a frequency inside the "Digital Mode" boundaries. These boundaries can be fully customized in the Band Map by clicking the Digital Band Map button or selecting Router | Options | Digital Band Map.

**NOTE:** Use “Select by frequency” only if your radio does not have a dedicated mode (PKT, DIG, DATA, or USB-D/LSB-D etc.) for audio based digital modes like PSK31, MFSK, OLIVIA, AFSK-RTTY etc. and you must use USB/LSB/FM for digital operation.

**Use VOICE settings:** VOICE settings will be used regardless of frequency and mode (USB/LSB or FM). This should be used with most Yaesu transceivers, late model Icom transceivers that support USB-D and LSB-D and the Elecraft K3. Router will select "DIGITAL" when it detects the special digital modes and use the "VOICE" settings for USB/LSB and FM.

**Use DIGITAL settings:** DIGITAL settings will be used regardless of frequency for USB/LSB or FM.

The **VOICE** and **FSK/DIGITAL** settings can independently specify whether audio generated by **microHAM CODEC** should be sent to the microphone jack or line input based on the operating mode.

**VOICE settings:**

**Microphone jack, DVK control** (default): The audio from microHAM CODEC is connected to the transceiver's microphone jack when transmitting under DVK control - including while recording DVK messages with "On Air recording" selected.

**Microphone jack, logger and DVK control:** The audio from microHAM CODEC is connected to the transceiver's microphone jack when transmitting under DVK control or when commanded by user software (e.g., a logging program).

**Line input (rear):** The audio from microHAM CODEC is connected to the transceiver's rear panel (line) input.

**Remote microphone** The audio from microHAM CODEC is connected to radio microphone jack all the time and does not switch to the local microphone. This selection is useful for use with computer based transmit audio DSP processing (for example, 3<sup>rd</sup> party audio equalizer software) or for use with remote operation of MKII.

**FSK/DIGITAL settings:**

**Line input (rear):** Audio from microHAM CODEC is connected to the radio rear panel (line) input all the time. This is the default setting for FSK/Digital operation.

**Microphone jack.** Audio output of microHAM CODEC is connected to radio microphone jack all the time.

**NOTE:** The graphic is "live" and shows the current audio routing. The grey lines show the selected audio path and the red lines show those paths currently transferring audio. The graphic is an excellent tool for troubleshooting the audio configuration.

**Sound Card:** is only visible with Vista and Windows 7. It shows the Name, Mixer ID, Wave In ID and Wave Out ID for each input/output in the computer. The ID numbers are necessary to properly configure of some applications (for example: WSJT, MMVARI etc.).

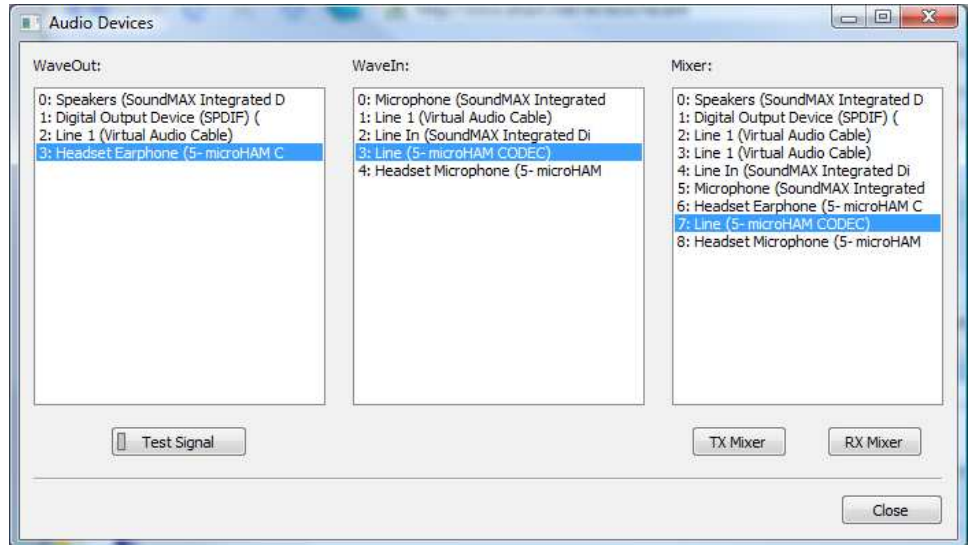

**Sound card overrides microphone:** When checked, audio from the sound card can override signal from microphone even if footswitch is depressed. "Restore serial PTT and audio routing" must be selected on the PTT tab to avoid disabling audio from the sound card when the footswitch is released.

## **Microphone Selection:**

microKEYER II supports two microphone inputs.

The RJ-45 input on the rear panel supports the stock transceiver microphone, including any microphone "button" controls – if the transceiver microphone uses a connector other than an RJ-45, use the supplied adapter.

The 3.5 mm front panel jack can be configured to support electret or dynamic headset or boom microphones.

**Front:** always use front panel (3.5 mm) **EXT MIC** input

**Rear:** always use rear panel (RJ-45) mic input

**Auto:** automatically select microphone. If both microphones are connected, use the front panel microphone if the footswitch is used and use the rear panel microphone (hand mic) if the microphone PTT is used.

The black box will show the selected microphone.



**NOTE:** The black box here and on other tabs in Router is “live.” It indicates which settings are currently in use. When the black box turns gray, it indicates that Router lost connection with the radio or has expired information (CAT port problem). While the boxes are gray, the settings may not be correct.

## **Transmit Monitor:**

microKEYER II includes a monitor amplifier that provides 2 watts to a user supplied speaker. Router will select the audio source to be monitored based on the operating mode. The monitor level can be set independently for each source/mode.

In CW, sidetone is selected – the sidetone frequency is selectable from 338, 450, 675 and 1350 Hz. Sidetone can be enabled for all CW output or only manual (paddle) input. In voice mode, DVK output is selected and in Digital mode the sound card output is selected.

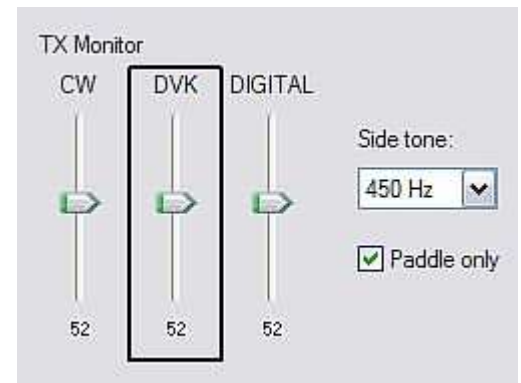

**NOTE:** TX Monitor contains ONLY transmit audio and CW sidetone generated by microHAM CODEC. It does not include receive audio from the transceiver. .

## AUDIO MIXER TAB

**NOTE:** The Audio Mixer Tab is not present in Windows Vista or 7 due to operating system limitations. Windows Vista and 7 take exclusive control of the sound card and do not allow any application to control the overall level or the select/mute switches for any audio "endpoint" (input or output). The Windows 2000 and Windows XP Hardware Abstraction Layer (HAL) that the Audio Mixer tab requires is not present in Vista and Windows 7. Because that capability is missing, Router cannot perform the audio control functions. Audio levels must be set using a combination of the Windows Volume Mixer and the Sound Control Panel.

The sound card configuration depends on the capability of your application software. Some software can directly control the sound mixer controls some can not. Router's Audio Mixer tab provides the ability to store and recall level settings to the presets for each application (or operating configuration).

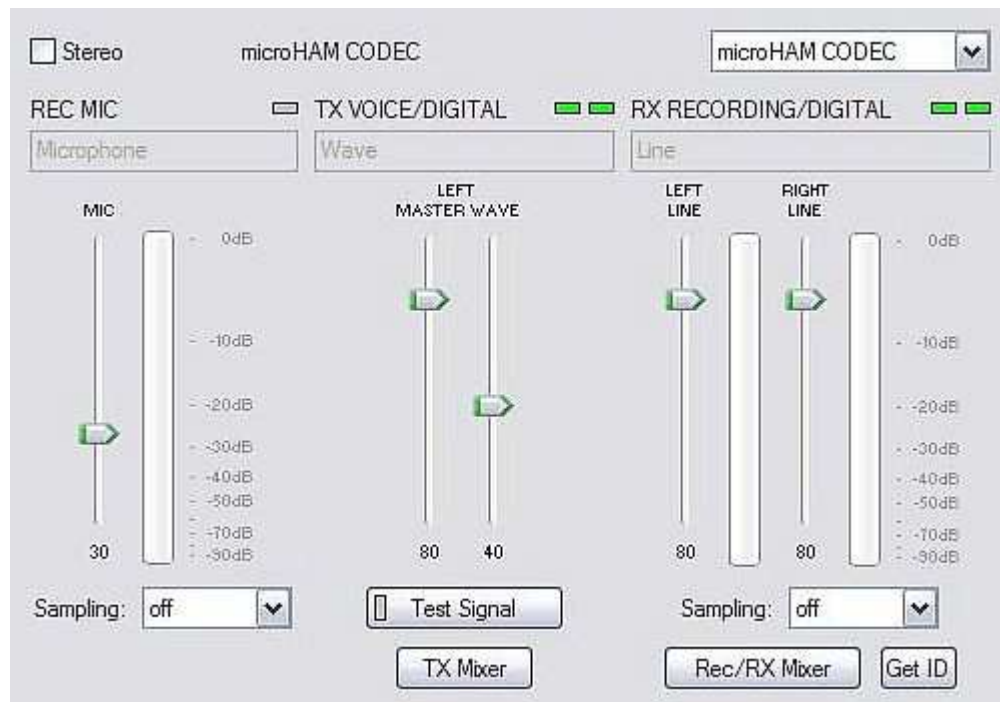

Select microHAM CODEC to use the internal sound card in *microKEYER II*.

The Audio Mixer can operate in Stereo or Mono mode depending on the **Stereo** check box. If Stereo is checked, Router will display separate controls for the left and right Wave, Line Out (Volume) and Line In channels. If Stereo is not selected, the Audio Mixer tab will display a single set of controls and will mute the right channel. *microKEYER II* uses the left channel for all output but in some cases you may want to use the right channel for another purpose (for example, when used with the microHAM *micro2R - u2R*).

**NOTE:** Windows can reassign sound cards "on the fly" and Router may not always select the correct mixer if you have more than one sound card in your system. To confirm that the proper mixer has been assigned, click the Get ID button and confirm that microHAM CODEC is selected. If the correct sound card is not selected, restart Router.



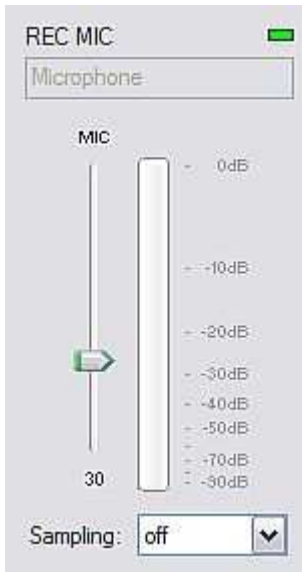

### **REC MIC (microphone recording level)**

**VU meter:** this "stacked LED" display shows the audio level into the analog to digital controller. Note, the display is active only if a sample rate is selected and the recording mic is selected.

This control adjusts the microphone recording level for recording DVK messages in the application (logger).

**Sampling:** sets the sample rate used for the REC MIC level displays.

Because of the nature of the Windows sound system, it is best to set the sample rate to a multiple of the sample rate (or "clock rate") used by your logging program for recording DVK messages.

### **TX (transmit levels)**

These controls adjust the output (transmit) levels. If the channels are active, the green rectangle will be on. If not, click the **TX Mixer** button and unmute the master Volume (Speaker) and Wave controls.

There are two (or four) sliders, the WAVE slider and MASTER slider (the Master Volume or Speaker control).

As a starting point, set the MASTER level to about 80% and the WAVE level to about 50%. Adjust WAVE for proper drive when using digital modes or playing voice messages from a logging program that includes DVK capabilities. Adjust the MASTER only if necessary to keep the WAVE control from operating at one end of its range.

**Test Signal:** causes *microKEYER II* to output a 1500 Hz audio tone for setting the transmit output level.

**TX Mixer:** this button opens the Windows Volume Control (Playback Mixer) for the selected sound card.

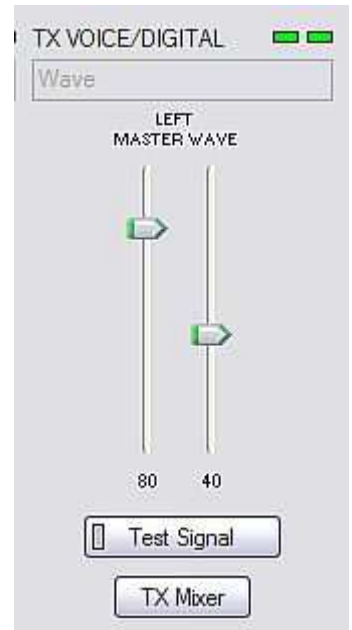

Some tips from Geoff Anderson, G3NPA:



**TIP:** If you have achieved the correct settings for the transmit levels (with audio compression disabled), changing from a single tone to the PSK idle should make transmit power drop by at least 50% as observed on an RMS or average reading meter. This change in power is correct. If you do NOT see a 50% (or more) change, you are probably over driving the radio. Please note that some radios have inbuilt power meters which give a PEAK reading and therefore the change in level discussed above will not be observed.



**TIP:** Don't fall into the trap of thinking that because the transmit signal looks good on the waterfall that your actual signal is OK. All the waterfall is showing during transmit is the local audio and NOT the transmitted signal.

## **RX RECORDING/DIGITAL (logger audio recording or digital decode levels).**

**VU meter:** this "stacked LED" display shows the audio level into the analog to digital controller. Note, the display is active only if a sample rate is selected.

*microKEYER II* shows one slider for each input – Left for the Main RX and Right for the Sub RX. Keep the sliders at about 80% and use the RX Main and RX Sub pots on the front panel for adjustment. When correctly adjusted, the input signal should never show RED.

**Sampling:** sets the sample rate used for the RX level displays.

Because of the of the way the Windows sound system handles multiple access to the sound card, always turn off the level displays (set Sampling: off) when they are not in use.

**Rec/RX Mixer:** this button opens the Windows Record (Input) Mixer for the selected sound card.

**GET ID:** this button will retrieve the name and number of the sound card. The name can be used to verify that the correct sound card has been selected. The Wave In ID can be used to configure software that identifies sound cards only by number.

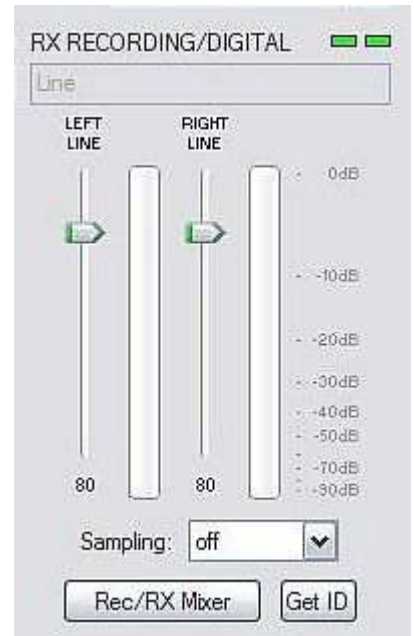

## **AUTOMATIC INPUT SELECTION**

Router automatically switches the inputs of microHAM CODEC based on the mode decoded from the transceiver (CW, Voice, or FSK/Digital). The active (selected) input is indicated by the green "LED(s)" above the sliders. The input can be selected by clicking on the gray LED or by invoking Windows Mixer (click on the Rec/RX Mixer button).

Line In is always selected in CW and FSK/Digital modes because the microphone input has no use. In VOICE modes, Router remembers the user's last selection. choice.

**NOTE:** When Router's DVK is used, the input will automatically be switched to microphone for recording and returned to the user's selection when the recording is finished.

## PTT TAB

The PTT tab allows configuring PTT operation.

### PTT INPUTS:

microKEYER II has six PTT sources:

- PTT generated by the logging program on the virtual COM port RTS or DTR
- 2<sup>nd</sup> PTT generated by an external application on the virtual COM port RTS or DTR  
PTT and 2<sup>nd</sup> PTT behave the same and generate the same **Serial PTT** input.
- A foot switch attached to the rear panel RCA jack.
- The PTT switch of the microphone connected to the RJ45 MIC jack.
- WinKey generated PTT.
- The sound card generated "Auto PTT."

### PTT OUTPUTS

microKEYER II has four PTT outputs: PTT1, PTT2, PA PTT and LNA PTT. PTT1 and PTT2 are brought out to the DB37 Radio connector. PAPTT and LNAPTT are RCA jacks for connecting to external devices.

**PTT1** is wired to the radio microphone jack and is generally used for CW and VOICE modes.

**PTT2** is wired to the radio Accessory jack and is used to switch the radio into transmit in DIGITAL and FSK modes.

**NOTE:** PTT2 or "rear panel" PTT is used by some radios to mute the microphone and disable speech processing circuits (clippers, audio equalizers, transmit DSP, etc.) that can distort digital modulation.

**PA PTT** is on the microKEYER II rear panel. It is designed for controlling an amplifier. PA PTT will close before PTT1 and PTT2 by the amount of **PTT lead** and open after the transceiver PTT by **PA PTT tail** setting.

**NOTE:** PAPTT tail should be set to provide a few milliseconds of delay after the transceiver PTT releases. Some transceivers produce RF even after their "amplifier PTT" drops and the delay will prevent "hot switching on release".

**LNA PTT** is on the microKEYER II rear panel. It is designed for bypassing a low noise preamplifier (LNA) or disabling receive antennas during transmit. LNA PTT is enabled by checking the **LNA PTT** box. LNA PTT will close before PTT1 and PTT2 by the amount of **PTT lead** and open after the transceiver PTT by **LNA PTT tail** setting.

microKEYER II can select PTT1 or PTT2 based on the mode reported by the transceiver. If Router is not able to read the operating mode from your radio (radio does not have computer control port or does not report usable mode information), you can select one of four fixed "no radio" modes or one "no radio" mode with manual (keyboard/keypad) mode selection.

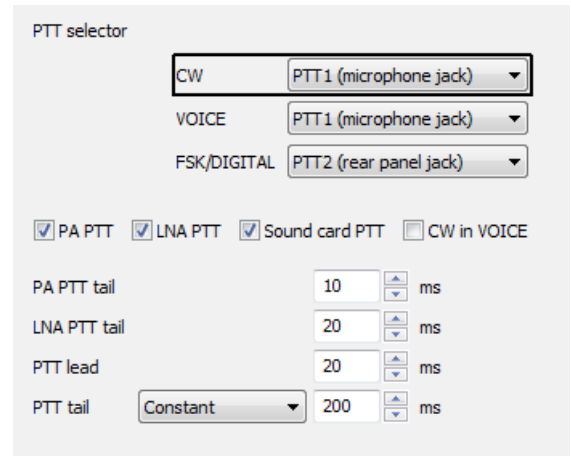

PTT selector

CW PTT1 (microphone jack)

VOICE PTT1 (microphone jack)

FSK/DIGITAL PTT2 (rear panel jack)

PA PTT  LNA PTT  Sound card PTT  CW in VOICE

PA PTT tail 10 ms

LNA PTT tail 20 ms

PTT lead 20 ms

PTT tail Constant 200 ms

Router groups operating modes into three classes: CW, Voice (USB, LSB, AM and FM) and FSK/DIGITAL. The available PTT options are:

**CW:**

- PTT1 (microphone jack),
- QSK (no transceiver PTT, PA PTT and LNA PTT include only PA/LNA PTT tail)
- Semi Break-in (no transceiver PTT, PA PTT and LNA PTT include PTT tail and PA/LNA PTT tail)
- PTT2 (rear panel jack).

**VOICE:**

- PTT1 (microphone jack)
- PTT2 (rear panel jack).

**FSK/DIGITAL:**

- PTT1 (microphone jack),
- PTT2 (rear panel jack),
- PTT1 & PTT2 (both jacks).

**PA PTT:** Enables PA PTT

**LNA PTT:** Enables LNA PTT

**Sound card PTT:** Enables automatic PTT when the sound card is producing audio. The presence of sound card audio presence is indicated by yellow SC led on front panel.

**CW in VOICE:** Enables CW output in Voice modes. Please note, this function must be supported by the transceiver. CW in Voice always operates without transceiver PTT (Semi Break-in).

**PTT lead:** Specifies lead-in delay.

In CW with PTT1, PTT2 or Semi Break-in, PTT lead is the time between activation of PTT1, PTT2, PA PTT and LNA PTT and the first CW output. Transceiver PTT (PTT1/PTT2), PA PTT and LNA PTT all activate at the same time.

In CW with QSK, PTT lead has no effect. The leading edge of PA PTT and LNA PTT are coincident with the CW output.

In VOICE and FSK/DIGITAL, PA PTT and LNA PTT lead transceiver PTT (PTT1 or PTT2) by the amount of PTT lead.

**PTT tail:** Defines how long PTT 1 or PTT2 remains closed after the last CW character. PTT tail can be set to a constant value or can be proportional to the CW speed between seven (1.00 wordspace) and ten (2.00 wordspace) dot lengths.

**PA PTT tail:** Defines the time that PA PTT remains closed after transceiver PTT (PTT1 or PTT2) and/or PTT IN opens when switching from transmit to receive.

**LNA PTT tail:** Defines the time that LNA PTT remains closed after transceiver PTT (PTT1 or PTT2) and/or PTT IN opens when switching from transmit to receive.

**NOTE:** LNA PTT tail should always be greater than or equal to PA PTT tail.

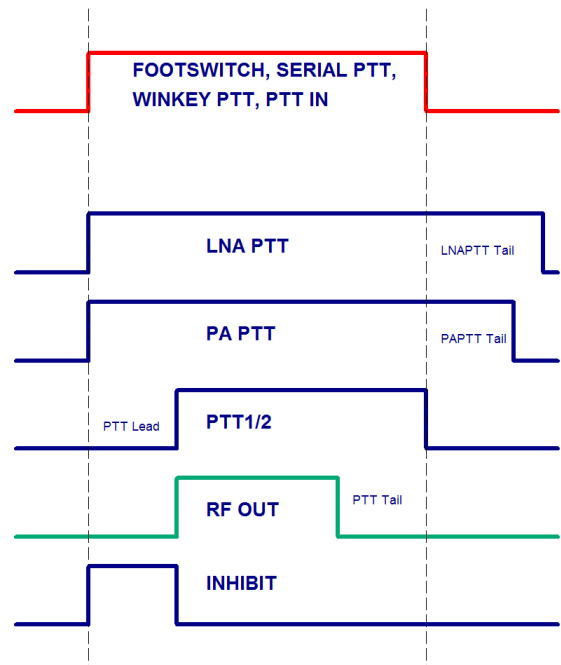

## FOOTSWITCH SEQUENCER

Additional functions can be associated with the footswitch (or hand mic PTT). *microKEYER II* recognizes when the footswitch is closed (pressed) or open (released) and can manipulate CW, FSK, PTT and audio routing when the footswitch is closed or opened.

**Mute serial CW** - if checked, serial CW (DTR or RTS) from an application program will be muted while the footswitch is pressed. If **Restore serial CW** is checked, CW will resume when the footswitch is released (if it has not already ended). If **Restore serial CW** is not checked, application generated CW will remain suppressed until the application releases PTT.

**Mute serial FSK** - if checked, the FSK ports will be blocked while the footswitch is pressed. If **Restore serial FSK** is checked, FSK will resume when the footswitch is released (if it has not already completed). If **Restore serial FSK** is not checked, FSK will remain suppressed until the application releases PTT.

**Restore serial PTT and audio** - if checked, application generated serial PTT will be restored and audio routing will return to the “serial PTT” setting when the footswitch is released. If **Restore serial PTT and audio** is not checked, audio will only return after the application releases PTT.

When foot switch is pressed

- Mute serial CW
- Mute serial FSK

When foot switch is released

- Restore serial PTT and audio routing
- Restore serial CW
- Restore serial FSK

## CW/WinKey TAB

This tab provides the configuration for the WinKey based, internal CW keyer. A complete WinKey manual can be downloaded from: <http://k1el.tripod.com/files/Winkey10.pdf>. Thanks to Steve Elliott, K1EL for this great product.

WinKey can be controlled by a logging program or operate in stand alone mode controlled by Router. Router controls the speed range, Paddle mode and other timing characteristics of WinKey. When an application (logger) opens WinKey, Router plays no part in buffer handling and speed control. All other settings remain under Router control, application settings are discarded to avoid timing issues and to keep WinKey behavior consistent across applications.

**NOTE:** WinKey parameters are stored separately for each Preset. This allows quick selection of parameters by choosing different preset. The Paddle swap parameter can be also controlled from attached PS/2 keypad.

**WARNING:** Do not change parameters while an application (logger) actively accessing WinKey.

When WinKey is closed, the basic operating parameters can be adjusted on this tab. Every change is applied immediately.

### Paddle Mode

- Iambic A (Curtis)
- Iambic B (Accu-keyer)
- Ultimatic (Single lever)
- Bug Keyer (Vibroplex emulation)

**NOTE:** To connect a straight key to MKII, use "Bug Keyer" mode. The straight key should be connected between ring and sleeve of a three conductor plug. The tip must be open.

The screenshot shows the WinKey configuration interface. On the left, under 'Paddle mode', there is a dropdown menu set to 'Iambic B (Accu-keyer)'. Below it are radio buttons for 'Priority' with options 'dit' and 'dah'. A 'Paddle setpoint' is set to 50%. There are checkboxes for 'Disable paddle memory', 'Swap paddles', 'Auto space', and 'CT space'. On the right, there are several numerical settings with up/down arrows and units: 'Speed pot min' (10 WPM), 'Speed pot max' (40 WPM), 'Farnsworth speed' (0 WPM), 'DIT / DAH = 100 /' (300), 'Weighting' (50 %), '1st extension' (0 ms), and 'Keying compensation' (0 ms).

**Priority** – Ultimatic mode offers a choice if DIT or DAH priority for dual lever paddles. If no priority is selected, the keyer works in a "last paddle wins" mode.

**Paddle set point** - controls when WinKey begins looking for a new paddle press after sensing the current one. The default value is one dit time (50) and is adjustable in percent of a dit time.

**Disable paddle memory** – When checked, DIT (or DAH) insertion is disabled.

**Swap paddles** - Reverse paddle sense for left handed operation or improperly wired paddle.

**Auto space** - Keyer generates automatic character space.

**CT space** - Selects "contest" word space (six elements long instead of seven).

**Speed pot min/max** - Min/Max value of the front panel speed knob (9) in range 5 to 99 WPM.

**Farnsworth speed** – Sets the Farnsworth keying speed (10 to 99 WPM range, 0 disables this feature).

**DIT / DAH** - DIT/DAH ratio from 1:2 to 1:4 in hundreds. Accepted numbers are from 200 to 400.

**Weighting** - Weighting in percentage (from 10 to 90%).

**1<sup>st</sup> extension** - Extension of the first dit or dah in milliseconds (QSK only).

**Keying compensation** - Extension of each dit and dah in milliseconds (QSK only).

## CW MESSAGES TAB

On this tab you can define nine CW messages of up to 50 characters each which are stored in EEPROM. Each memory may have a programmable repeat delay and/or call another memory.

Message content	Jump to	Delay [s]	Test on CW	
1 W4TV	-	0	Test	Store
2 DE W4TV	-	0	Test	Store
3 TU 5NN	-	0	Test	Store
4 CQ TEST DE W4TV W4TV	-	0	Test	Store
5 55N	-	0	Test	Store
6 5NN	-	0	Test	Store
7 CQ CQ DE W4TV W4TV	-	0	Test	Store
8	-	0	Test	Store
9	-	0	Test	Store

Par. 5
Set WPM 05
Set Key 05
Set Wait 05

Merge
Cancel WPM

Store All

Load from File
Save to File

Commands which may be included in a memory are:

- Merge:** merge two characters without a letter space – [M]AS will sound AS .-...
- Cancel WPM:** restore speed set by the Speed pot.
- Set WPM:** force speed to the selected value regardless of position of speed knob.
- Set Key:** close CW output for selected time in seconds.
- Set Wait:** wait selected seconds during playback.
  
- Jump to:** used for looping a message or calling another message
- Delay:** sets the delay in seconds before looping or calling another message
  
- Test:** plays a message without storing it
- Store:** saves one message to microKEYER II memory
  
- Store All:** saves all messages to microKEYER II memory
  
- Load from File:** loads all messages from file
- Save to File:** saves all messages to file

Messages can also be saved and replayed using an external keyboard or numeric keypad attached to the PS/2 jack. See: External Keyboard.

**NOTE:** Messages are not saved or loaded with Presets

## FSK MESSAGES TAB

On this tab you can define nine FSK messages of up to 50 characters each which are stored in EEPROM. Each memory may have a programmable repeat delay and/or call another memory.

Message content	Jump to	Delay [s]	
1 W4TV	-	0	Store
2 [CR]DE W4TV	-	0	Store
3 TU 5NN	-	0	Store
4 [CR]CQ TEST DE W4TV W4TV	-	0	Store
5 55N	-	0	Store
6 5NN	-	0	Store
7 [CR]CQ CQ DE W4TV W4TV	-	0	Store
8	-	0	Store
9	-	0	Store

Commands which may be included in a memory are:

- CR & LF:** Insert Carriage Return/Line Feed
- Figure:** Insert special Figure character
- Letter:** Insert special Letter character
- Blank:** Insert special Blank character
- Letter:** Insert special Bell character
  
- Jump to:** used for looping a message or calling another message
- Delay:** sets the delay in seconds before looping or calling another message
  
- Store:** saves one message to microKEYER II memory
- Store All:** saves all messages to microKEYER II memory
  
- Load from File:** loads all messages from file
- Save to File:** saves all messages to file

Messages can also be saved and replayed using an external keyboard attached to the **PS/2** jack. See: External Keyboard.

**NOTE:** Messages are not saved or loaded with Presets



## DVK TAB

microKEYER II allows recording and playing an unlimited number of messages (limited only by the capacity of the computer hard drive) - nine voice messages per bank. Banks can be managed with Rename, Add and Remove buttons. **Rename** to rename the current bank, **Add** to create a new bank, and **Remove** to delete the current bank. Bank selection is provided by **Bank** box.

Each memory may repeat with a programmable delay (loop) or can be chained with another memory using external keyboard or keypad.

While a DVK message is being recorded or played microKEYER II uses the DVK mixer settings. When recording or playback is done, the settings in the Audio Mixer are restored. DVK mixer settings are not stored with presets but in the message banks. This means each bank can have its own levels (slider position). It also allows each bank to be configured for the voice of a different operator if microKEYER II is used in a club station or other multi-operator situation.

DVK memories can be recorded or played under logger control if your logger supports microHAM Control Protocol.



Under Windows 2000 or XP, Router DVK uses the sound card defined on the Audio Mixer Tab.

**For Vista and Windows 7**, select:

**REC MIC:** "Headset Microphone (microHAM CODEC)"

**TX:** "Headset Earphone (microHAM CODEC)"

**REC MIC** slider adjusts microphone level during message recording.

**TX:** The Left Master/Wave controls operate the same as the TX VOICE/DIGITAL controls on the Audio Mixer tab. There will be only a single MASTER control under Windows Vista.

If "**On Air Recording**" box is checked, the microphone is connected to both the sound card and the transceiver input while messages are being recorded. On Air Recording is not available in Windows Vista.

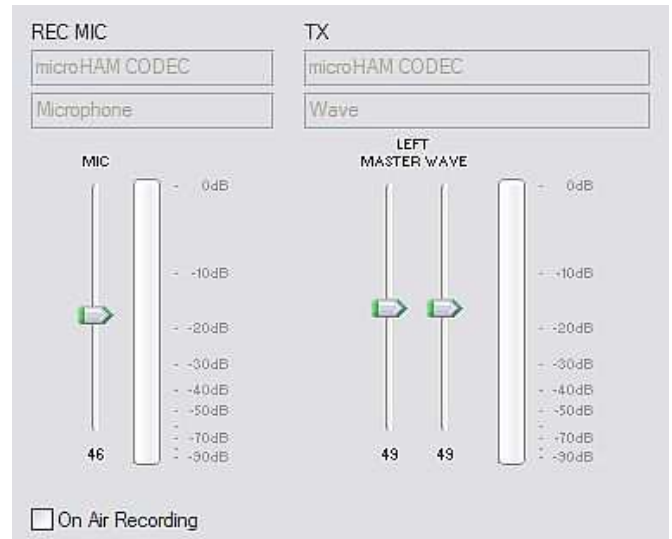

**DO NOT** use the foot switch or microphone PTT when recording.

## KEYBOARD TAB

The Keyboard Tab controls the operation of a PS/2 keyboard or numeric keypad connected to the PS/2 jack. It is also possible to define control functions for the numeric keypad. Custom controls are invoked by pressing and holding the asterisk key (\*) with Numkey0-9.

### General:

**QWERTZ layout** – configures the keyboard for a QWERTZ layout.

### FSK from keyboard:

**Diddle LETTERS:** send the LETTERS character whenever there is nothing in the transmit buffer.

**UOS:** shift back to LETTERS case whenever a space is encountered in the transmit data.

**Type ahead:** enables type ahead when using a PS/2 keyboard. Characters are transmitted after a **space** (word mode) or when the buffer has reached its limit (16 characters).

FSK from keyboard:

- Diddle LETTERS
- UOS
- Type ahead

### CW from keyboard:

**Type ahead:** enables type ahead when using a PS/2 keyboard. Characters are transmitted after a **space** (word mode). or when the buffer has reached its limit (16 characters).

**Speed Step:** set the amount by which the Up/Down or NUM +/- keys change the CW speed.

CW from keyboard:

- Type ahead
- Speed step:
- WPM

### Auto numbering:

**Leading zero as T:** sends leading zeros in contest report as T. For example 001 will be send as TT1.

**Zero as T:** sends all "zeros" in contest report as T. For example number 100 will be send as 1TT.

**One as A:** sends all "ones" in contest report as A. For example number 101 will be send as AOA.

**Nine as N:** sends all "nines" in contest report as N. For example number 199 will be send as 1NN.

**Report 5NN:** send 5NN before contest serial number.

Auto numbering:

- Leading zero as T
- Zero as T
- One as A
- Nine as N
- Report 5NN

The PS2 and FH-2 sub tabs allow assigning control functions to PS/2 and FH-2 style keypads. FH-2 connects to pins 2 and 3 of the PS/2 jack. microHAM does not supplies adapter for FH-2 keypad.

**NOTE:** FH-2 cannot be connected to the transceiver and to the MKII at the same time.

## DISPLAY TAB

The display tab provides controls for configuring the *microKEYER II* display.

The screenshot shows the configuration interface for the microKEYER II display. It is organized into three main columns. The first column, labeled 'Upper line', contains a 'Background' dropdown menu currently set to 'Operating frequency' and a 'Reports' list with 15 items. The second column, labeled 'Lower line', contains a 'Background' dropdown menu currently set to 'System power' and another 'Reports' list with 15 items. The third column contains two vertical sliders: 'Contrast' (set to 32) and 'Light' (set to 60). At the bottom of the window, there is a 'Report time' field set to 1500 ms, and two buttons: 'Set Strings' and 'Set Defaults'.

Each line can display one of eight default (background) functions and any of “temporary” status reports. The “background” functions are those that appear at idle. The status messages appear depending on operating mode.

**Contrast:** controls the LCD contrast

**Light:** sets the LCD backlight brightness

**Report time:** sets the length of time that transient (status change) reports remain visible

**Set Strings:** set the “Welcome Message” to be displayed when *microKEYER II* is initialized.

**Set Defaults:** returns the display to factory settings

## SYSTEM SETTINGS TAB

**System Power** displays the voltage at the +13.8 V input jack (+12V to +16V)

System power  
13.3 V OK  
 Enable sleep mode

**Enable sleep mode:** When checked, *microKEYER II* will sleep when the radio power (DB37, pin 1) is turned off and Router is not running.

**CI-V port settings:** The CI-V port will emulate an Icom transceiver and “broadcast” the frequency data if Router can determine it by polling the rig or reading polling data from the logging program. The transceive broadcast can be used to control peripherals that use Icom protocol.

CI-V port settings  
Function: Operating frequency  
Baud rate: 9600 bps Address: 6A

There are six frequencies which can be broadcast: Operating frequency, VFO A frequency or VFO B frequency, TX frequency, RX frequency, or Sub RX frequency. In practice, operation of each setting depends on the transceiver and its CAT protocol. All options may not work with some transceivers.

**Baud Rate:** sets the baud rate for the CI-V broadcast

**Address:** sets the “from” CI-V address for the CI-V broadcast

**iLink port settings:** sets the function of the TTL serial lines on the iLink connector. The iLink Port supports two optional functions:

iLink port settings  
Function: Auxiliary port Parameters

**Auxiliary Port or Antenna Control.**

**NOTE:** Connecting *microKEYER II* to an antenna controller or auxiliary RS-232 device requires a TTL to RS-232 converter like the *microHAM iLINK/SteppIR*. Pin-out documentation for the iLINK port can be found in Appendix A.

**Auxiliary (general purpose) serial port:** When the iLINK port function is set to Auxiliary port, data is transferred between the “Auxiliary” virtual port defined on Ports tab and the iLINK serial lines without modification. Maximum data rate is 19,200 baud.

**Antenna Control:** *microKEYER II* can control SteppIR and Ultra Beam antennas using the antenna's native protocol. For connection information see your antenna's manual.

Native mode control has two advantages over control based on transceiver frequency only.

- *microKEYER II* protects the antenna while elements are moving (retuning). Transmission can not be initiated using PTT while the antenna is retuning. When using VOX, *microKEYER II* will not activate PAPTT to prevent a power amplifier from operating the SteppIR is tuning.
- When operating in split frequency mode, the transmit frequency is sent to the SteppIR to prevent retuning between transmit and receive when operating with wide splits.

**NOTE:** This function does not replace the OEM controller, the original controller is still used.

**IMPORTANT:** The original SteppIR controller **MUST** be switched into the GENERAL mode. Manual band changes on controller front panel are disabled. Autotrack must be turned on with the SDA-100. Use 9,600 bps or lower for reliability.

**IMPORTANT:** Baud rate must be set to 19200 bps for Ultrabeam. A special DB9M-DB9M cable must be used between the *microHAM iLink-SteppIR* adapter and Ultrabeam controller. Connect pins 2-3, 3-2, 5-5 from end to end and a jumper between pin 4 (DTR) and 8 (CTS) on the Ultrabeam end.

## 6 – Setting Audio Levels

For optimum operation of *microKEYER II*, the audio levels must be set properly. The function of each control was described in the AUDIO MIXER and DVK sections of the manual. Following a step-by-step approach will help you to set proper levels.

### Configuring *microKEYER II* for your radio:

1. Connect the original microphone for your transceiver directly to the mic input of the transceiver.
2. Connect the transceiver to a dummy load and set it to USB or LSB.
3. Turn off any speech processor, key the radio, talk into the mic and while watching the ALC indication rotate the transceiver Mic Gain so that the ALC peaks at the top of the ALC zone.

**Do not adjust the Mic Gain again.**

4. Disconnect the microphone from your transceiver and attach the mic cable from MK II.
5. Open the cover of *microKEYER II* and check the position of the jumpers for the microphones.
6. Set the three trimmers (located just to the front of the RADIO DB37) to the middle of their range.
7. Connect the radio mic to the RJ-45 connector and select the "Rear" mic on the Audio Switching tab. Set both VOICE and FSK/DIGITAL to "Microphone jack".
8. Key the transceiver, speak into the radio microphone and adjust the MIC (center) trimmer so that the transceiver ALC peaks at the top of the ALC zone.
9. Disconnect the radio mic from the RJ-45 connector. Connect your headset or boom microphone to the EXT MIC jack and select the "Front" mic on the Audio Switching tab.
10. Put the transceiver into transmit, speak into the microphone and adjust the EXT MIC (left) trimmer so that the transceiver ALC peaks at the top of the ALC zone (same as step 9).

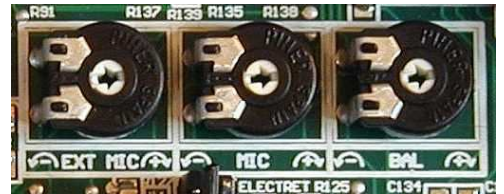

### Setting audio levels in Windows 2000 and Windows XP:

(If you are using Vista or Windows 7, skip to the next page) .

1. Select the Audio Mixer Tab in Router and set REC MIC sampling to 44100.
2. Click on the "LED" above the REC MIC to select the microphone.
3. Speak into the microphone and adjust the Mic level so that the VU-meter peaks as high as possible into the yellow but does not go into the red on voice peaks
4. Set the TX control on the front of *microKEYER II* to 12 o'clock.
5. Set the TX VOICE/DIGITAL Master slider to 80% and the Wave slider to 60%
6. Switch your transceiver to AFSK mode (PKT, DIG or DATA for Yaesu, LSB-D or USB-D for current Icom transceivers, RTTY or RTTY-R on K2 and USB or LSB for Kenwood, TenTec and older Icom transceivers). Do not select RTTY or FSK; they do not use the audio input.

7. Select the Audio Switching tab. Set both FSK/DIGITAL and VOICE to "Line input (rear)"
8. Go back to the Audio Mixer tab and click the "Test Signal" button. Adjust the TX WAVE slider for normal (rated) output on your transceiver while keeping the ALC meter as low as possible.  
**NOTE:** For the Elecraft K3 only: Do not adjust the TX WAVE slider. Instead, adjust the Line In level (Mic Gain) until the ALC shows five (5) bars.
9. Select the Audio Switching tab. Set both FSK/DIGITAL and VOICE to "Microphone jack."
10. Set your radio to USB or LSB and click the "Test Signal" button. Adjust the BALANCE (right) trimmer so that the ALC reading on your transceiver sets at the top of the ALC zone (rated output).
11. This sets proper levels for and all modes. You may want to store these Router settings to the last preset. Click Preset | Save as, choose position number 12, name it Default and store settings.



**TIP:** When you start to create your own presets, always begin by selecting the "default" preset. This will configure the audio levels to the proper state before starting any customization.

12. Select the DVK tab in Router and set the REC MIC slider to the same level as the REC MIC on the Audio Mixer tab. Set the TX MASTER and WAVE sliders to the same level as the TX VOICE/DIGITAL sliders on the Audio Mixer tab.
13. Record a message and adjust the REC MIC slightly if necessary so that the REC MIC VU Meter does not peak into the red.
14. Play back the message and adjust the WAVE slider so that the transceiver ALC meter peaks at the top of the ALC zone (the same level as steps 9 and 11).

**NOTE:** Levels in the DVK tab are independent of those in the Audio Mixer. They are stored with the message banks, not with presets.

### **Setting audio levels in Vista and Windows 7:**

1. Select Router's Audio Switching tab and click the "Sound Card" button.
2. On the "Audio Devices" window, select "Headset Earphone (microHAM CODEC)" in the Mixer and WaveOut boxes.
3. Click the TX Mixer button. If the Mixer does not appear, open the Windows Sound Control Panel and select the "Playback" tab.
4. Click the "Test Signal" button on the Audio Devices screen and verify that the VU Meter for "Headset Earphone (microHAM CODEC)" reaches maximum. If not, turn off Test Signal, restart Router and return to step 2. Turn off the Test Signal.
5. Close the Audio Devices window but leave the Sound Control Panel open.
6. Select the "Playback" tab in the Sound Control Panel
  - double click "Headset Earphone (microHAM CODEC)"
  - click Levels tab and unmute the Headset Earphone and mute the Microphone
  - click Balance and set LEFT and RIGHT to 80%, then click OK twice.

7. Select the "Recording" tab in the Sound Control Panel
    - double click "Headset Microphone (microHAM CODEC)"
    - click Levels tab and unmute the Microphone
    - Preset the Microphone level to 70%
  8. While speaking into the microphone, adjust the Microphone level until you see the top green bar light on the VU meter for "Headset Microphone (microHAM CODEC) on the Recording tab, then click OK.
  9. Set the TX control on the front of *microKEYER II* to 12 o'clock.
  10. Select the "Playback" tab in the Sound Control Panel
    - double click "Headset Earphone (microHAM CODEC)"
    - click the Levels tab
  11. Switch your transceiver to AFSK mode (PKT, DIG or DATA for Yaesu, LSB-D or USB-D for current Icom transceivers, RTTY or RTTY-R on K2 and USB or LSB for Kenwood, TenTec and older Icom transceivers). Do not select RTTY or FSK; they do not use the audio input.
  12. Select the Audio Switching tab. Set both FSK/DIGITAL and VOICE to "Line input (rear)"
  13. Click the Sound Card button to open the Audio Devices window and select "Headset Earphone (microHAM CODEC)" in the WaveOut box. .
  14. Click the "Test Signal" button and adjust the Headset Earphone level (in the Levels window of the Sound Control Panel) for normal (rated) output on your transceiver while keeping the ALC meter as low as possible.
- NOTE:** For the Elecraft K3 only: Do not adjust the TX WAVE level. Instead, adjust the Line In level (Mic Gain) until the ALC shows five (5) bars.
15. Select the Audio Switching tab. Set both FSK/DIGITAL and VOICE to "Microphone jack."
  16. Set your radio to USB or LSB and click the "Test Signal" button on the Audio Devices window. Adjust the BALANCE (right) trimmer so that the ALC reading on your transceiver sets at the top of the ALC zone (rated output).
  17. If you cannot balance the microphone and sound card levels with the trimmer, return it to the midpoint. Go back to Step 9, increase or decrease the TX Level control slightly and repeat steps 10 - 17 until balance is achieved.
  18. This sets proper levels for and all modes.
  19. Select the DVK tab in Router and set REC MIC and TX to 70%.
  20. Record a message and adjust the REC MIC slightly if necessary so that the REC MIC VU Meter does not peak into the red.
  21. Play back the message and adjust the TX level so the transceiver ALC meter peaks at the top of the ALC zone (the same level as steps 16).

**NOTE:** Under Vista and Windows 7, DVK levels are separate from those set by other applications. DVK levels are stored with the message banks.

## 7 - System Considerations

**microKEYER II** can be used with a wide variety of software. The capabilities of those packages will have large influence on the level of computing power needed to utilize *microKEYER II*.

When used with Windows based contest logging applications like CTWin, N1MM Logger, Win-Test, and WriteLog or Windows based general logging applications like DXBase, DXLab Suite, DX4WIN, Logger 32 and others, the microHAM control and interface application “microHAM Router” must run along side the application program. Since both the logging programs and microHAM Router are real-time applications, system performance will be dependent on both CPU speed and the amount of available RAM.

While *microHAM Router* will run on slower computers, the minimum tested system is a 1.6 GHz Pentium IV, Windows 2000, 512 MB RAM, CD-ROM, and USB 1.1 port. Whether Router can run as designed on slower machines with less memory and leave enough resources for application programs has not been determined. *microHAM Router* is not supported on any 16 bit version of Windows (95, 98, ME, SE).

In order to provide sufficient performance for simultaneous operation of microHAM Router, a logging application, Internet connectivity and other accessory programs, the recommended system is a 2 GHz PC compatible computer with Windows XP Home or higher, 1 GB RAM, CD-ROM, root USB 2.0 port, a transceiver with supported control protocol and logger, control, or digital mode software.

*microKEYER II* is also compatible with Apple Macintosh systems running OS 10.5 or later. It is directly supported by MacLoggerDX ([www.dogparksoftware.com/MacLoggerDX.html](http://www.dogparksoftware.com/MacLoggerDX.html)) by Don Agro, VE3VRW as well as *µH Router* and cocoaModem (<http://homepage.mac.com/chen/w7ay/Site/Applications/index.html>) by Kok Chen, W7AY.



## 8 - EXTERNAL KEYBOARD/KEYPAD

**NOTE:** The keyboard/Keypad must be PS/2. A USB device with PS/2 adapter will not work properly.

microKEYER II includes the ability to generate FSK or CW, record and play CW, FSK or VOICE messages using a PS/2 keyboard or numeric keypad connected to the PS/2 jack. A numeric key pad is sufficient to record and play CW and DVK messages, control CW speed (WPM) or play a serial number message. "Live" CW or FSK (RTTY) requires a full keyboard.

### **Switching modes:**

The keyboard or keypad mode will follow the mode of the transceiver with Transmit Focus. If the radio is not computer controllable or its control protocol is not supported, the keyboard or keypad can be used to switch Router's operating mode if the "radio" selection is "no radio (mode selected manually)."

<b><i>STATUS INDICATION</i></b>				
<b><i>NUM</i></b>	<b><i>CAPS</i></b>	<b><i>SCROLL</i></b>	<b><i>play/rec</i></b>	<b><i>mode</i></b>
OFF	x	x	playback	
ON	x	x	recording	
x	OFF	OFF		CW
x	OFF	ON		DIGITAL
x	ON	OFF		FSK
x	ON	ON		VOICE

### **Playing messages:**

A message is started by pressing F1-F9 on the keypad or 1-9 on the number pad. A message can be aborted with the ESC key or the zero key on the number pad. Messages may be made to repeat (loop) by pressing DEL (period) on the number pad while the message is playing. The default (minimum) wait time after ending a message and starting again is one second. The pause time may be set from 1 to 9 seconds by entering the desired delay immediately after pressing DEL. For example, 1 <DEL> 5 will start message number 1 and cause it to repeat with five a second delay. Pressing zero (0) will terminate a message loop.

### **Recording messages:**

Recording is started (and stopped) by pressing NUM LOCK. To start recording, press NUM LOCK followed by the number of the message to be recorded. To abort a message without saving, press zero on the number pad or Escape. To end recording and save the message press NUM LOCK.

In CW, microKEYER II stores characters as they are echoed from the internal WinKey2: only those characters actually transmitted are stored. However, CW messages may be recorded from either paddles or the keyboard. The gap "I" and other WinKey commands cannot be entered from the keyboard but may be used in messages loaded from Router's CW/FSK Messages tab.

In FSK, all characters entered from the keyboard are stored.

<i>std. key</i>	<i>Numeric Keypad</i>			<i>CW mode</i>	<i>FSK mode</i>	<i>Voice mode</i>
	NUM LOCK		start/stop recording of message (recording mode is indicated by NUM LED)	✓	✓	✓
	NUM *		Tune (can be canceled by keys NUM 0 or ESC, or by the paddle)	✓		
ESC	NUM 0		playback: stop transmitting (message or any characters in buffer)	✓	✓	✓
			recording: abort recording without storing the message			
F1-F9	NUM 1 – NUM 9		playback: start message playback	✓	✓	✓
			recording: set message number			
	NUM DEL		playback: periodically repeat last message (default interval is 1 second, it can be changed by pressing the number on number pad)	✓	✓	✓
			recording: no function			
	NUM /		Switch between "speed control mode" and "serial number mode" (serial number mode is indicated by SCROLL LED, if present)	✓		
ALT			When held allows setting the serial number			
PG UP	NUM +	WPM control	Increase CW speed (step defined by configuration)	✓		
UP		S/N mode	Increment number by one without transmitting	✓		
PG DN	NUM -	WPM control	Decrease CW speed (step defined by configuration)	✓		
DN		S/N mode	Decrement number by one	✓		
HOME	NUM ENTER	WPM control	Reset CW speed to pot (knob) value	✓		
ENTER		S/N mode	Transmit number with optional report and increase number by one (format defined by configuration)	✓		
ENTER			transmit CR and LF characters		✓	
F10			Toggle PTT – alternative to foot switch	✓	✓	
CAPS LOCK			Switch between CW mode and FSK mode (FSK mode is indicated by CAPS LED)	✓	✓	
SPACE			transmit space (if "type ahead" mode is active all buffered characters are transmitted before this space)	✓	✓	
			transmit gap (one-half dit delay time), this character cannot be recorded to a message from keyboard – it may only be entered from Router	✓		
0-9 a-z "#\$%&'()*+,-./:;<=>?@\			transmit character, if "CW type ahead" mode is active character is pushed to type ahead buffer to be transmitted after next space. Note: some special characters are mapped to standard prosigns (see WinKey manual)	✓		
0-9 A-Z !"#\$%&'()*+,-./:;<=>?@\			transmit character, if "FSK type ahead" mode is active character is pushed to type ahead buffer to be transmitted after next space		✓	

## 9 - HARDWARE SPECIFICATIONS

**USB:** USB 2.0 Full speed, USB 1.1 compatible

**Power consumption:**

USB – less than 100mA

Power supply – 400mA at 13.8V (max. 16V)

**Radio Port:** Rx/D, Tx/D – max. 57,600 Baud, RTS/CTS handshake supported  
Levels: TTL, inverted TTL, open collector bus, RS232

**Aux Port:** TTL – Rx/D, Tx/D, no handshake – 9600 baud maximum

**CI-V Port:** open collector bus – 9600 baud

**CW:** open collector, max 30V/400mA

**FSK:** open collector, max 30V/400mA

- supports 5/6/7 bit data, 1/1.5/2 stop bits, up to 300 baud

**PTT1:** open collector, max 30V/400mA

**PTT2:** open collector, max 30V/400mA

**PA PTT:** selectable by internal jumpers

open collector, max. 45V @ 0.8A

relay contact, max. 48V AC/DC @ 1A

**LNA PTT:** selectable by internal jumpers

open collector, max. 45V @ 0.8A

relay contact, max. 48V AC/DC @ 1A

**Foot Switch:** active when closed to ground, max load: 1 mA at 5V

**PTT IN:** active when closed to ground, max load: 1 mA at 5V

**Monitor:** Mono, 2 Watts @ 4 Ohm speaker

**Audio Out:** 600 Ohm, 4V p-p max.

Left channel

AC coupled

**Audio In:** 50K Ohm, max 4Vpp

dual channel (Stereo)

AC coupled

**Dimensions:** **W** 2325mm (9.125") x **H** 44mm (1.73") x **D** 105mm (4.125")

**Weight:** 1.3 kg (1.875 lbs.)

## 10 - PACKAGE CONTENTS

The product includes microKEYER II, USB cable, 3.5 mm audio cable (sub-receiver audio), RCA to RCA cable (PTT IN), coaxial 2.1mm/5.5mm power plug, and CD-ROM containing the microHAM USB Device Router program and documentation.

If the shipment is incomplete, please contact us at the following address:

E-mail: [support@microham.com](mailto:support@microham.com)

fax : +421 2 4594 5100

by Post: **microHAM s.r.o.**  
**Nadrazna 36**  
**90028 Ivanka pri Dunaji**  
**SLOVAKIA**

## 11 - WARRANTY

microHAM warrants this product for three (3) years. The product must not be modified in any way or the warranty is voided. Cables are warranted against defects in materials and workmanship for a period of 60 days.

**What is covered:** During the warranty, *microHAM*, s.r.o., will repair or replace defective product at their sole discretion. You must send the unit postpaid with a copy of the original invoice to the distributor from whom you purchased the product. *microHAM* will pay return shipping.

**What is not covered:** This Limited Warranty does not cover (1) correction of installation or software errors in the user's computer(s), (2) damage caused by misuse, negligence, user modifications or failure to follow the user manual, (3) connection to improper or excessive voltage or voltage surges, (4) the incorrect installation of any cables connected to the device by the user or (5) weather related storm, lightning or electrostatic discharge damage.

**microHAM USB Device Router** (the software) is provided "as is" without guarantee of compatibility with any specific operating system, computer, peripheral or accessory.

microHAM assumes no liability or responsibility for damage to other devices or injuries to persons as a consequence of using our products.

If the terms of the above warranty are not acceptable, return the unit, all associated documents and accessories in the original unopened package, prepaid, to microHAM or to your supplier for refund less shipping and a restocking fee.

## DECLARATION OF CONFORMITY



**Federal Communications Commission  
Statement (USA)**

This device complies with Part 15 of the FCC Rules. Operation is subject to the following two conditions: (1) this device may not cause harmful interference, and (2) this device must accept any interference received, including interference that may cause undesired operation.



**European Union Declaration of Conformity**

*microHAM*, s.r.o. declares that the products:

**Product Name: microKEYER II**

**Conforms to the following Product Specifications:**

**EN 55022: 1998 Class B following the provisions of the Electromagnetic Compatibility Directive 89/336/EEC**

## APPENDIX A – DB37 RADIO CONNECTOR

Pin #	Label	Description
1	POWER	Auxiliary 12V power input
20	RS232 RTS	RS232 radio port RTS output
2	RS232 CTS	RS232 radio port CTS input
21	IF-FIF	iface matrix - used for configuring desired levels for radio control interface
3	IF IN	iface matrix - used for configuring desired levels for radio control interface
22	FIF IN	iface matrix - used for configuring desired levels for radio control interface
4	RS-TTL OUT	iface matrix - used for configuring desired levels for radio control interface
23	FILTER OUT	iface matrix - used for configuring desired levels for radio control interface
5	CI-V IN	iface matrix - used for configuring desired levels for radio control interface
24	RS232 IN	iface matrix - used for configuring desired levels for radio control interface
6	CI-V OUT	CI-V bus output "open collector"
25	RS232 OUT	RS232 TXD output
7	FIF OUT	FIF-232 TXD output "TTL"
26	IF OUT	IF-232 TXD output "TTL"
8	FILTER IN	RXD input for all interfaces
27	PTT1	PTT1 output "open collector" generally used as all mode front panel MIC PTT
9	PTT2	PTT2 output "open collector" generally used as rear panel digital modes PTT
28	CW OUT	CW output "open collector"
10	PULL UP	+5V through a 10K resistor
29	FSK OUT	FSK output "open collector"
11	FSW IN	Hand Mic PTT input
30	MIC #1	RJ45 Microphone jack pin #1
12	MIC #2	RJ45 Microphone jack pin #2
31	MIC #3	RJ45 Microphone jack pin #3
13	MIC #4	RJ45 Microphone jack pin #4
32	MIC #5	RJ45 Microphone jack pin #5
14	MIC #6	RJ45 Microphone jack pin #6
33	MIC #7	RJ45 Microphone jack pin #7
15	MIC #8	RJ45 Microphone jack pin #8
34	MIC GND	Microphone ground
16	MIC	Microphone signal
35	RADIO MIC IN GND	Radio MIC ground
17	RADIO MIC IN	Radio MIC signal
36	RADIO AF IN GND	Radio AUDIO input ground
18	RADIO AF IN	Radio AUDIO input signal
37	RADIO AF OUT GND	Radio AUDIO output ground
19	RADIO AF OUT	Radio AUDIO output signal
SHELL	GND	Radio and power GND

## iLINK – miniDIN 6

Pin #	Label	Description
1	DATA	I2C Data channel for expansion (TTL)
2	RX EXT	Serial Data In (TTL)
3	GND	Connected to system ground and case
4	+5 V	+5V output, max.100mA.
5	CLOCK	I2C Data Clock (TTL)
6	TX EXT	Serial Data In (TTL)
SHELL	GND	Connected to system ground and case

## PS/2 – miniDIN 6

Pin #	Label	Description
1	PS/2 DATA	TTL PS/2 DATA line
2	RESPAD	Input for resistive keypad (FH-2), max.+5V/1mA
3	GND	Connected to the system ground and case.
4	+5 V	+5V output, max.100mA.
5	PS/2 Clock	TTL PS/2 CLOCK line
6	n/c	Not connected
SHELL	GND	Connected to system ground and case

## APPENDIX B – RFI Considerations

A few guidelines to eliminate problems caused by RFI:

1. Proper grounding of all electronic equipment is critical. A modern station contains many, diverse, types of interconnected and interrelated equipment: transceiver, power amplifier, computer, control boxes, switch boxes, and power supplies. Each of these must be individually grounded with a separate connection to a single common ground point, thus forming a star ground connection.

Proper grounding of computers, both "desktop" and laptop is often overlooked. A separate ground connection should be run from the computer to the station common ground point. The best place to ground a computer is a screw with a good connection to the case. On a laptop, this is often the retaining screw on a D-sub connector (e.g, VGA output); on a "desktop" it is often the screws holding the power supply.

It is absolutely important to prevent ground currents from flowing to the common ground point by way of the signal cable. If you use a microHAM "keyer," a good test is to remove the DB15/DB37 connector and USB cable from the keyer and measure the resistance from the shell of the DB15/DB37 to the shell of the USB cable. There should be NO MORE than FIVE (5) Ohms (and preferably less than TWO Ohms) between them.

Note: many PC manufacturers fail to provide an adequate connection between the shell of the USB connector and the PC case. If this is the case, a connection can be established by bridging a folded piece of aluminum foil between the shell of the USB connector and the PC case.

2. Power all your equipment from a single wall outlet. The "safety ground" often exhibits excessive noise between power outlets - sometimes often due to other equipment powered from the same branch circuit. It is always better to avoid this source of noise/interference. It is also a good idea to check the power distribution for loose connections, reversed neutral/ground, open ground and other wiring problems.
3. Sometimes, the USB cable can be a source of RF interference - the cable might have inadequate shielding or the transceivers in PC might be improperly designed causing data flowing inside the cable to be reflected as a common mode current on the shield of the cable. This common mode current can radiate a significant "digital noise." If this is the source of your problems, it can be significantly reduced or eliminated using ferrite chokes on both ends of the cable. Two or three turns through a #31 mix FT240 toroid are better than the common snap-on ferrites of unknown mix.
4. Often, another cause of RFI problems is a common mode current flowing along the antenna feedline into the shack. It is a common misconception that the only thing required of a feedline is that it have low SWR. Unfortunately, a low SWR does not guarantee low common mode current. These common mode currents are conducted into the shack where they can radiate from the feedline, induce currents in any nearby metal object, and/or be conducted into the interconnected equipment. Common mode currents on a feedline are indicated by problems that differ in intensity from one band to another or from one end of the band to another, by problems that change when a feedline is moved or its length changed, where the problem moves from one piece of equipment to another based on band, and/or where the severity changes with transmit power level. The solution is to use common mode chokes to prevent the current from entering the shack. This topic has been given thorough treatment in recent works by W1HIS and K9YC.

W1HIS: <http://www.yccc.org/Articles/W1HIS/CommonModeChokesW1HIS2006Apr06.pdf>  
K9YC: <http://www.audiosystemsgroup.com/RFI-Ham.pdf>



## APPENDIX C – Tracking

**NOTE:** Tracking is experimental code started in Router 7.5.0 for linking the transceiver frequency to a tracking receiver. Mode linking and bidirectional frequency tracking are not currently supported.

microHAM will be expanding features and adding support for additional radios in the future. The initial version has been tested with Perseus SDR only.

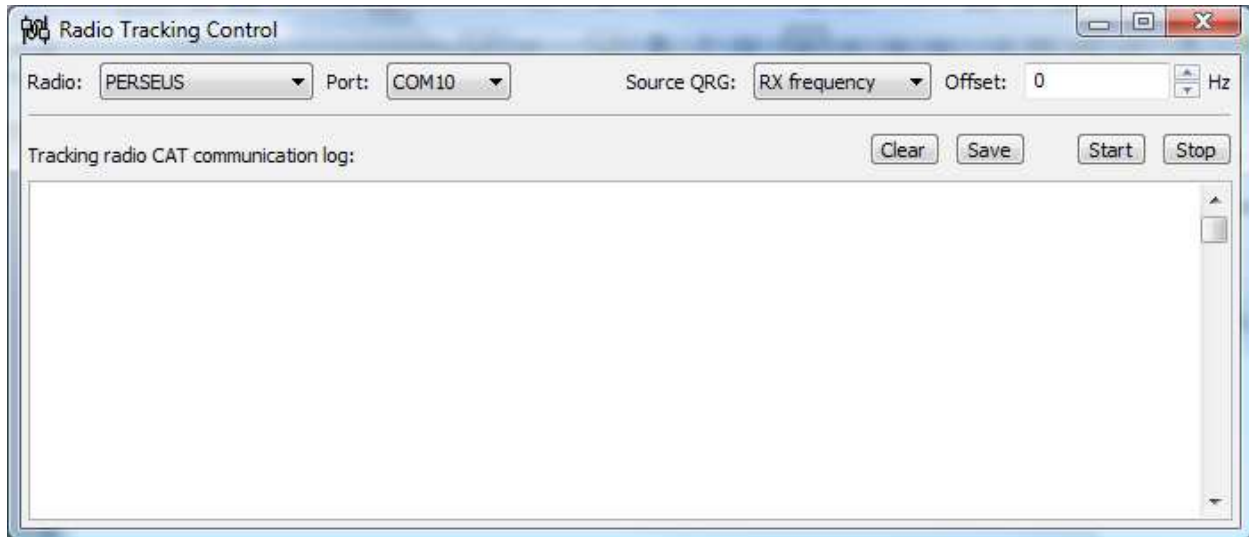

### PERSEUS

**Radio:** PERSEUS

**Port:** COM10

**Source QRG:** Defines which frequency will be used for SDR tracking

**Offset:** Specifies frequency offset from tracking frequency send to SDR for tracking.

**NOTE:** COM10 is the default COM port for PERSEUS can only be changed in the Windows registry (refer to the Perseus manual). Make sure that the COM10 is not used by any other device in PC. Then create virtual COM10 in Router and do not use this COM port number for any purpose other than tracking.