

CP-6AR

Operation Instructions



Description

- ① The CP-6AR is a six-band vertical antenna for HF band.
- ② Compact, light weighted and very easy to assemble.
- ③ It is completely self-supported and does not need any guy wires.
- ④ Trap radials could be concentrated on one direction instead of spreading them around the antenna. This is especially convenient if the antenna is installed on balcony railing or window side of condominiums and urban apartments.
- ⑤ Since the antenna is direct DC ground at the feed point, coaxial cable and transceiver are being protected from the high voltage caused by lightning.
- ⑥ Center frequencies of the antenna are adjustable in each band simply by change the length of each radial element.
- ⑦ Top loading structure utilizing capacitive hat enables the antenna to complete with full quarter wave length antennas in its performance.
- ⑧ It is rigid and rugged enough to withstand the wind pressure over 90MPH.
- ⑨ Mast brackets are adjustable to accept 1 1/5" to 2 1/3" diameter mast.
- ⑩ Feed point section is kept waterproof by covering it with support pipe.
- ⑪ 10m FM band compatible.

Parts Number

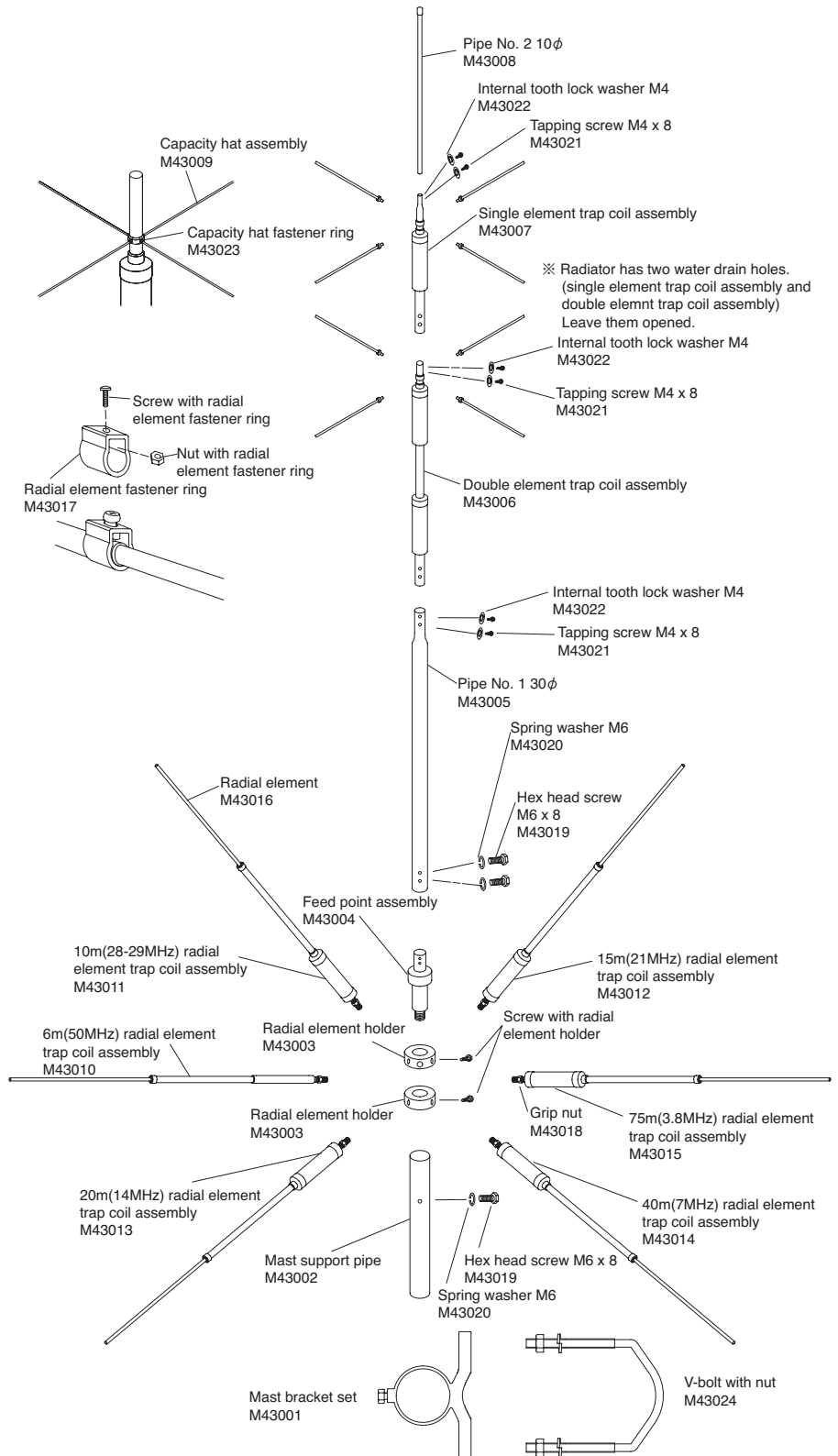

Parts Description

Parts #	Description	Qty
M43001	Mast bracket set	2
M43002	Mast support pipe	1
M43003	Radial element holder	2
M43004	Feed point assembly	1
M43005	Pipe No. 1 30φ	1
M43006	Double element trap coil assembly	1
M43007	Single element trap coil assembly	1
M43008	Pipe No. 2 10φ	1
M43009	Capacity hat assembly	8
M43010	6m(50MHz) radial element trap coil assembly	1
M43011	10m(28-29MHz) radial element trap coil assembly	1
M43012	15m(21MHz) radial element trap coil assembly	1
M43013	20m(14MHz) radial element trap coil assembly	1
M43014	40m(7MHz) radial element trap coil assembly	1
M43015	75m(3.8MHz) radial element trap coil assembly	1
M43016	Radial element	6
M43017	Radial element fastener ring	6
M43018	Grip nut	6
M43019	Hex head screw M6 x 8	3
M43020	Spring washer M6	3
M43021	Tapping screw M4 x 8	6
M43022	Internal tooth lock washer M4	6
M43023	Capacity hat fastener ring	2
M43024	V-bolt with nut	2

(Fig-1)

-Note-----

<<Installing the antenna>>

- ① Don't install on a rainy or windy day since it is dangerous.
- ② Don't attempt to install the antenna only by yourself. Installing the antenna alone on the roof may lead you dangerous accident. Always ask your friends for help installing the antenna.
- ③ Don't drop the antenna, tools and attachment when installing the antenna in the height. Install the antenna before assembling it on the ground.

<<Antenna location>>

- ① If the CP-6AR is located on the roof of a house or top of a building, look around the roof to see if there are any obstacles such as an electronic wire or TV antenna. The CP-6AR has to be located as far away as possible from those things to obtain its maximum performance. Installing the antenna too close to the building wall may cause bad effect for electrical characteristics of the antenna.
- ② Don't install the antenna where is easily reachable by people.
- ③ Install the antenna firmly not to fall down due to the strong wind. Even if falling down the antenna, locate the antenna at the safe place where people and building are not inflicted injuries.

<<Before transmitting>>

- ① Transmit after confirming if the antenna works normally by an SWR meter. If VSWR is less than 1.5, it is no problem. If VSWR is higher, stop transmitting and check if the parts of the antenna and coaxial cable are connected. If there are tall buildings or obstacles or the distance between the antenna and the ground is short, VSWR may not be lowered.
 - ※ Diamond Antenna SWR/POWER meter is an insertion type being connected between a transmitter and an antenna. Transmitting power and SWR can be measured with very simple operations. In addition with those conventional measurement, PEP (peak envelope power) on SSB mode can be measured with a PEP monitor function. With our Diamond's wideband and low insertion loss directional coupler those measurements can be performed with minimum effect in transmission line.

<<During transmitting>>

- ① Touching the antenna during transmission may cause to electrify. Pay attention not to touch the antenna especially for children if installing on a balcony railing.

<<Rumbling Thunder>>

- ① The thunder seems to rumble in the vicinity, don't touch the antenna and coaxial cable. When you don't use the radio, take off the cable from the radio.

<<If there is something wrong, stop transmitting immediately.>>

- ① Keeping transmitting with high VSWR may cause the radio to be damaged. Stop transmitting immediately and check the following matters. If it doesn't solve the problem, please ask the dealer or Diamond Antenna Corporation.

[Condition: If the antenna doesn't seem to receive well or propagate well]

Check 1: Is the antenna too close to the building wall? If the obstacles are too close to antenna, VSWR is higher and the radiation pattern is disturbed. Please install the antenna from the building as far away as possible.

Check 2: Did you assemble the antenna correctly? Please read the instruction again and reconfirm the assembly.

Check 3: Is the coaxial cable something wrong? Please check if soldering the connector is okay and the wire breaks by the volt-ohm meter.

• Antenna location

Resonate frequency of HF antenna can change based on location. Antenna should be mounted away from tree, building and other antennas.

- ① If the CP-6AR is located on the roof of a house or top of a building, look around the roof to see if there are any obstacles such as TV antenna or water reservation tank. The CP-6AR has to be located as far away as possible from those things to obtain its maximum performance.
- ② If the CP-6AR is installed on a balcony railing, installing the antenna too close to the building wall may cause bad effect for electrical characteristics of the antenna. Locate at least 2m to 5m (7' to 16') away from the building wall depending on structure of the building.

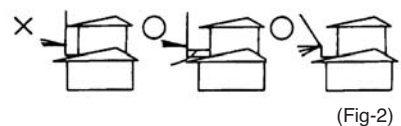

(Fig-2)

- <<Note>>**
- Fastening the radial element trap coil assembly tightly may be damaged.
 - In the case of spread around style radial elements, the turn to fix the radials is restricted. However, the radials of the lower frequencies are more influenced by the surrounding condition. Set the radials for 80m and 40m as far away as possible from the buildings.

- In the case of the one direction style radial elements, set the radial for 75m and one the radial for 40m at the both end. Pull one piece of the radial element holder down 2cm and fix it.

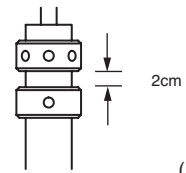

(Fig-3)

- In case of using the metallic stay wire, set the wire on the lower mast bracket set and attach the insulators at within 1m from the mast bracket set in order to insulate.
- It is possible to remove the radials you don't use the band for.

• Assembly Instruction

- ① Put radial element in each radial element trap coil assembly by referring to the typical element length listed in Table A and fasten it with element fastener ring. (Figure-4)
- ② Set grip nut rightly to treaded part of each radial element trap coil assembly.

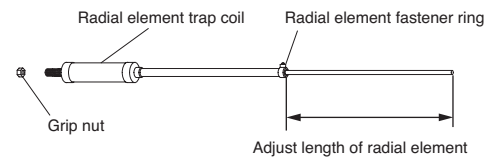

(Fig-4)

- ③ Connect pipe No.1, double element trap coil assembly, single element trap coil assembly and pipe No.2 in the vertical element section and fastening them with tapping screws and inner tooth washers by aligning holes in each joint section.
- ④ Attach four capacity hat assemblies to each capacity hat holder section. Capacity hat holders are set at the specified sections in the factory. Locations for those capacity hat holders are fixed at about 24cm (9.4") below the top end of single element trap coil assembly for upper capacity hat and about 24cm (3.1") below the top end of double element trap coil assembly for lower capacity hat respectively. Though, upper and lower capacity hat assemblies do not have to be aligned electrically, it looks better if it is aligned well.

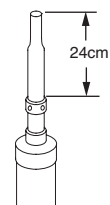

(Fig-5)

⑤ Attach mast support pipe to mast with mast brackets. Mast support pipe's tapping hole has to be placed above the brackets and it has to be pointed outside against the mast. Upper end of mast support pipe has to be placed more than 12cm(4.7") above the top end of the mast.

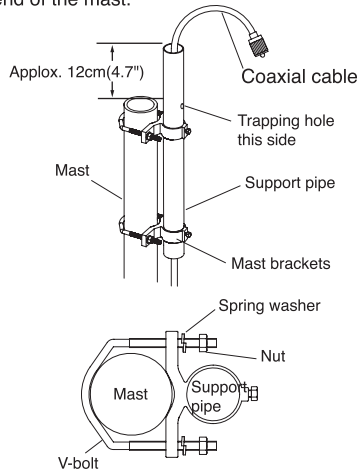

(Fig-6)

⑥ Place two radial element holders from upper end of the support pipe and fasten temporary with screwdriver. Do not fasten too tightly at this stage, otherwise feedpoint assemblies might not be put into the support mast later.

⑦ Connect a coaxial cable to feedpoint assemble through the support pipe. Then align the hole in the lower part of feedpoint assembly with the hole in the support pipe and secure them with hex head screw and spring washer.

⑧ Place vertical element on feedpoint assembly and fix with two hex head screws and spring washers.

⑨ Turn each radial element into radial element holders. Then align water drain hole in each radial element trap coil assembly downward by turning backward and fasten each element with grip nut, Note that 6m radial element does not have trap coil assembly.

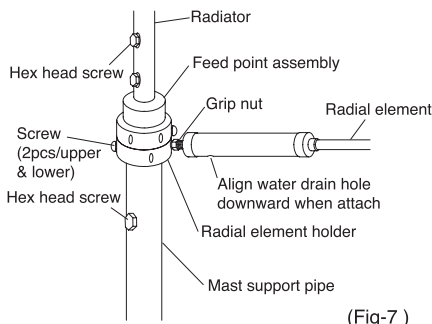

(Fig-7)

<<Note>>
To avoid breaking each radial element trap coil assembly, turn it into a holder lightly till it stops and turn backward to align water drain hole downward and secure with a screw.

• Adjustment

<<Note for frequency adjustment>>

Practice the following adjustment procedure at the place where the antenna is actually installed.

Test transmission for the adjustment has to be performed for as short time as possible and with as low RF power as possible. Maximum RF power rating of continuous wave (CW) is about 1/3 of it in SSB mode.

If the antenna is installed on a long balcony railing, the railing itself may work as a radial element and VSWR of the antenna may not be changed with the adjustment of attached radial element length. If resonant frequency of the antenna is within a desired range, the antenna can be used normally in this case. If resonant frequency is out of desired frequency range and adjustment is required, the antenna has to be isolated from the railing, moved to a different place or installed on a mast, which is at least 1m to 2m (3.3' to 6.6') long.

- ① Prepare suitable VSWR meter for operating frequencies and output RF power. Then connect it as shown in below.

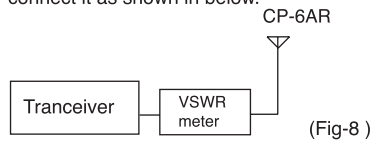

(Fig-8)

- ② Adjustment procedure can be started from any frequency you like. Transmit at desired frequency and trim adjustment length of radial element to have lowest VSWR at the frequency.

• Adjustment length of radial element

Adjustment length of each radial element is shown in the following table. If you do not have a VSWR meter, adjust it to a typical adjustment length.

Band	Spread radials	One direction radials	Length/Frequency
75m (3.8MHz)	Applox. 540mm	Applox. 450mm	50mm/ 10KHz
40m (7MHz)	Applox. 470mm	Applox. 440mm	10mm/ 10KHz
20m (14MHz)	Applox. 490mm	Applox. 400mm	15mm/ 20KHz
15m (21MHz)	Applox. 540mm	Applox. 460mm	32mm/ 50KHz
10m (28MHz)	Applox. 420mm	Applox. 380mm	35mm/ 50KHz
6m (50MHz)	Applox. 420mm	Applox. 300mm	50mm/ 1MHz

(Table A)

* If the radial element of a band is made longer, resonant frequency of the band is made lower proportionally.

* Though typical adjustment length of each radial element is set at center frequency of each band, it varies more or less depending on the place the antenna is installed.

Adjustment example:

If center frequency of 40m band is set at 7.050MHz and real center frequency when the antenna is installed is at 7.010MHz, then frequency difference between is: 7.050MHz (desired center frequency) - 7.010MHz (real center frequency) = 40KHz.

From Table A, adjustment length at 40m band is about 10mm per 10KHz, therefore: 10mm x 40KHz / 10KHz = 40mm
Since real center frequency is lower than desired center frequency, radial element has to be made 40mm shorter to have 7.050MHz center frequency.

* One direction style radial elements

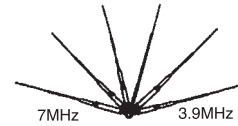

(Fig-9)

* Spread around style radial elements

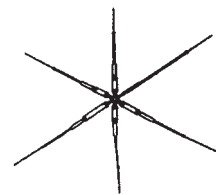

(Fig-10)

• VSWR

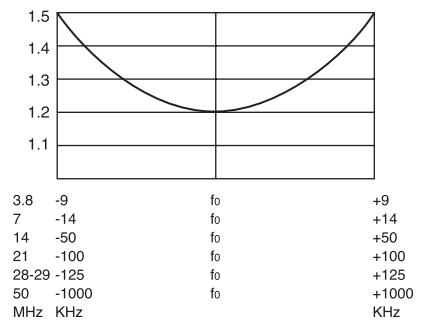

• Specifications

Frequency range	75, 40, 20, 15, 10, 6m (3.8, 7, 14, 21, 28-29, 50MHz)
Feed point Impedance	50Ω
VSWR	Less than 1.5
Maximum power rating	200W(SSB), 70W(FW/CW)
Maximum wind resistance	90MPH (40m/sec)
Vertical element length	153.5"(3.9m)
Radial element length	71"(1.8m)
Weight	9.71lbs (4.8Kg)
Mast diameter accepted	1 1/5" - 2 1/3" (30-62φ)
Design	6band trap vertical antenna with trap radials

Though these products purchased are manufactured under strict quality control, if damage is caused by transporting, ask your dealer promptly.

Design and specifications of these products will be changed for future improvement without advance notice.